

# RECI PROF CATALOGUE 2020





Reci Prof International B.V., founded in 1972, is a manufacturer and wholesaler of parts and components for milking machines and consumables for dairy farming. From our location in the south of the Netherlands, we deliver business to business to an extensive national and international network with a coverage ratio in more than 60 countries.

Our product range currently includes more than 4000 parts suitable for almost all brands of milking machines such as DeLaval, Westfalia, Miele, Fullwood, Dairymaster, Boumatic, SAC, Gascoigne Melotte and Strangko. To keep our program up-to-date, we are constantly researching and developing new products, so that we can continue to offer our customers the most complete range possible. Market trends are closely monitored by our experienced team.

We also can produce “Custom Molding” products, which means that these parts are manufactured exclusively for one customer or OEM. On request we can produce all parts from rubber, plastic or stainless steel on the basis of a drawing or model.

The components in the program are mostly produced from our own molds and there is also a close cooperation with leading manufacturers for which we act as importer or exclusive distributor.

**Our mission:**

Supply of added value to our customers, OEMs, technical dealers and distributors, with components for milking machines and dairy farming that are innovative, sustainable, high quality and competitive in price.

**Our vision:**

Our goal is to be recognized as one of the most specialized suppliers in the field of milking machine components and solutions in the world.

With this new catalog as a supplement to the website and webshop we provide you with all possible information. Our team will be happy to answer your questions and provide you with suitable advice.

**We look forward to a pleasant and successful collaboration!**



Chapter 1

# MILKING CLUSTERS AND ACCESSORIES

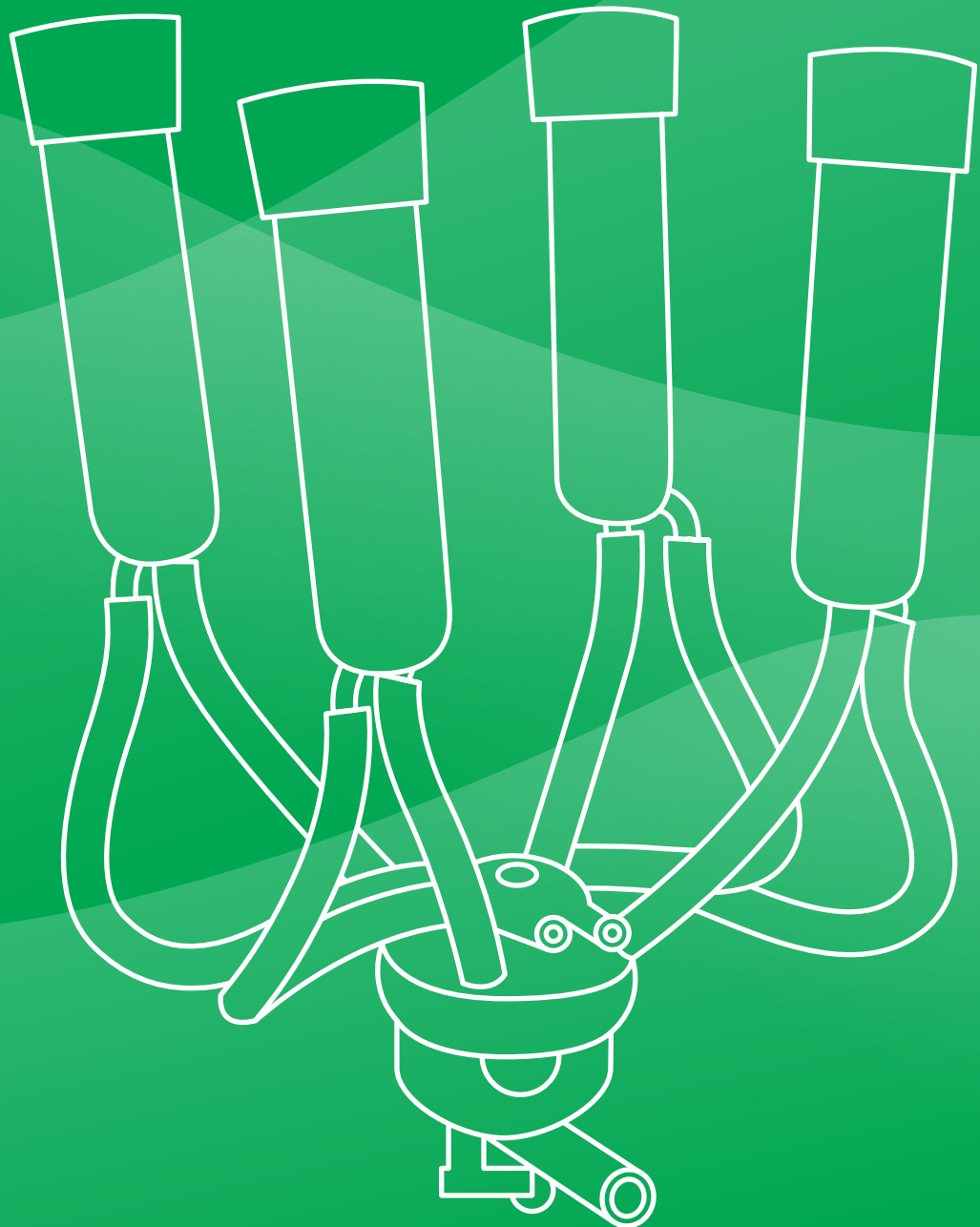



# Chapter 1 Milking clusters and accessories

RP Milking cluster	P7
Milking cluster for mini milkers and milk buckets	P7
S/S cluster extender	P7
Bracket support	P7
Plastic milk claw	P8
Milk claw Super Flo Light	P8
Bowl Galaxy	P8
Bowl corr. Boumatic Flostar	P8
Bowl corr. Dairymaster	P9
Milk claw corr. DeLaval 996.700-80	P9
Milk claw corr. DeLaval 960.200-80	P9
Milk claw corr. DeLaval	P10
Bowl corr. DeLaval TF 350	P10
Milk claw corr. DeLaval TF 360	P10
Milk claw without shut off corr. DeLaval TF 360	P11
Milk claw corr. DeLaval MC3	P11
Bowl corr. DeLaval Flo-Tek MK2	P11
Bowl corr. DeLaval Harmony + MCG TF 450	P11
Support for service arm corr. DeLaval	P12
Milk claw corr. DeLaval Germania	P12
Claw rubber corr. DeLaval	P12
Gasket corr. DeLaval	P12
Claw bowl corr. Manus	P12
Claw bowl corr. Manus Optimum	P13
Milk claw corr. Fullwood Freeway	P13
Claw bowl corr. Fullwood Clearflow	P14
Protecting gasket corr. Fullwood	P14
Claw bowl corr. Miele	P14
Gasket corr. Gascoigne Melotte	P14
Minicupring corr. Gascoigne Melotte	P14
Milk claw corr. Westfalia Classic 300	P15
Milk claw without shut off corr. Westfalia Classic 300	P15
Milk claw corr. Westfalia Classic 300 EVO	P16
Milk claw without shut off corr. Westfalia Classic 300 EVO	P16
Claw bowl 150 cc corr. Westfalia	P17
Claw bowl 200 cc corr. Westfalia	P17
Claw bowl corr. Westfalia Flo-Tek MK2	P17
Parts for milk claws corr. Westfalia	P17

Orbiter	P18
NuPulse	P18
Liners corr. Boumatic	P19
Liners corr. Dairymaster	P19
Liners corr. DeLaval	P19
Liners corr. Fullwood	P21
Liners corr. Gascoigne Melotte	P21
Liners corr. Impulsa	P22
Liners corr. Manus	P22
Liners corr. Miele	P23
Liners corr. Lely	P23
Liners corr. SAC	P23
Liners corr. Strangko	P24
Liners corr. Surge	P24
Liners corr. Westfalia	P24
Several Liners	P25
Liners corr. Milkrite	P25
Liners Westfalia (original)	P26
Teat cup shell corr. Boumatic 8517327	P26
Teat cup shells corr. DeLaval	P26
Teat cup shell corr. Surge	P27
Teat cup shells corr. Westfalia	P27
Teat cup shell corr. Milkrite	P27
Adapters corr. Fullwood	P27
Sight glass corr. DeLaval	P27
Sight glass corr. Fullwood	P27
Sight glass corr. Manus	P28
Sight glass corr. Westfalia	P28
Stop for liner	P28
Stop for liner ISO	P28
Stop for liner	P28
Stop for liner corr. DeLaval	P28

## RP Milking cluster

<b>1307543</b>	Model 180 cc   22 mm   light
<b>1307542</b>	Model 180 cc   24 mm   light
<b>1307541</b>	Model 180 cc   22 mm   heavy
<b>1307540</b>	Model 180 cc   24 mm   heavy
<b>1307547</b>	Model 400 cc   22 mm   light
<b>1307546</b>	Model 400 cc   24 mm   light
<b>1307545</b>	Model 400 cc   22 mm   heavy
<b>1307544</b>	Model 400 cc   24 mm   heavy
<b>1301734</b>	Liner   long   22 mm - 8 mm   corr. DeLaval 960.016-01
<b>1309888</b>	Liner   long   24 mm - 9,5 mm   corr. DeLaval 960.000-01
<b>1301165</b>	Liner   long   24 mm - 8 mm   corr. DeLaval 960.016-01



## Milking cluster for mini milkers and milk buckets

<b>1314008</b>	Milking cluster   complete
<b>1300050</b>	Milk claw   180 cc   2:2   with bumper   hook Ø 20 mm
<b>1300052</b>	Bowl   complete   with bumper
<b>1300051</b>	Bowl   only   180 cc
<b>1307329</b>	Gasket
<b>1300053</b>	Bumper
<i>Several parts available on request</i>	



## S/S cluster extender

<b>1307393</b>	Cluster extender   S/S   Ø 10-12 mm
----------------	-------------------------------------



## Bracket support

<b>1307550</b>	Bracket support   complete
<b>1307548</b>	Bracket support   only
<b>1307549</b>	Adapter
<b>1308347</b>	Pulsator   Nedlac 2000   blue lid   60:40



## Plastic milk claw

<b>1309643</b>	Milk claw   plastic   complete   150 cc   Ø 18 mm
<b>1310312</b>	Bowl   only
<b>1310313</b>	Claw Manifold   plastic   black
<b>1310315</b>	Gasket
<b>1300002</b>	Claw rubber   corr. DeLaval 960.207-01
<b>1310314</b>	Shut off valve



## Milk claw Super Flo Light/California

<b>1307308</b>	Milk claw   Super Flo Light/California   400 cc   2:2   450 gram
<b>1300057</b>	Bowl   complete
<b>1300056</b>	Bowl   only
<b>1307309</b>	S/S Claw Manifold
<b>1300055</b>	Gasket
<b>1300002</b>	Claw rubber   corr. DeLaval 960.207-01
<b>1300045</b>	Bumper
<b>1300009</b>	Shut off valve   long stem   34 mm
<b>1307310</b>	Pulse block   2:2
<b>1307312</b>	Pulse block for lower part
<b>1307313</b>	Hook
<b>1307314</b>	Bold
<b>1307315</b>	ACR bold   with spring



## Bowl Galaxy

<b>1301904</b>	Bowl Galaxy   with hole
<b>1301901</b>	Bowl Galaxy   without hole
<b>1307324</b>	Gasket



## Bowl corr. Boumatic Flostar

<b>1311300</b>	Bowl   only   Classic (2")
<b>1311304</b>	Bowl   only   Standaard (2 1/2")
<b>1311601</b>	Repair kit   9-pieces   with shut off
<b>1311603</b>	Repair kit   6-pieces   without shut off



## Bowl corr. Dairymaster

<b>1316296</b>	Bowl   without shut off   corr. Dairymaster SF212
<b>1316298</b>	Repair kit   corr. Dairymaster SF309
<b>1316297</b>	Bowl   with shut off   corr. Dairymaster SF201
<b>1316295</b>	Repair kit   corr. Dairymaster SF203



## Milk claw corr. DeLaval 996.700-80

<b>1300040</b>	Milk claw   150 cc   2:2   fits also the mini milker Friesland   corr. DeLaval 996.700-80
<b>1300041</b>	Milk claw   150 cc   4:1   fits also the mini milker Friesland   corr. DeLaval
<b>1301679</b>	Bowl   complete
<b>1300044</b>	Bowl   only
<b>1300047</b>	S/S Claw Manifold   2:2
<b>1300048</b>	S/S Claw Manifold   4:1
<b>1307328</b>	Gasket
<b>1301800</b>	Claw valve
<b>1300049</b>	Bumper
<b>1300046</b>	Shut off valve   short stem   23 mm



## Milk claw corr. DeLaval 960.200-80

<b>1300000</b>	Milk claw   180 cc   2:2   outlet Ø 14 - 16 mm   corr. DeLaval 960.200-80
<b>1300006</b>	Bowl   complete
<b>1300004</b>	Bowl   only
<b>1300003</b>	Gasket
<b>1300002</b>	Claw valve   corr. DeLaval 960.207-01
<b>1300008</b>	Shut off valve   short stem   23 mm
<b>1300009</b>	Shut off valve   long stem   34 mm
<b>1300076</b>	Air vent



## Milk claw corr. DeLaval

<b>1300015</b>	Milk claw   180 cc   2:2   outlet Ø 16 mm   corr. DeLaval
<b>1300019</b>	Bowl   complete
<b>1300018</b>	Bowl   only
<b>1300010</b>	S/S Claw Manifold   2:2
<b>1300017</b>	Gasket
<b>1300002</b>	Claw valve   corr. DeLaval 960.207-01
<b>1300025</b>	Bumper
<b>1308227</b>	Shut off valve   short stem   23 mm
<b>1300076</b>	Air vent



## Bowl corr. DeLaval TF 350

<b>1310163</b>	Bowl   only   corr. DeLaval TF 350
<b>1307322</b>	Protecting gasket   corr. DeLaval 989.397-01
<b>1308371</b>	Claw valve   corr. DeLaval 964.805-01
<b>1311905</b>	Hook   ACR   corr. DeLaval 996.984-81



## Milk claw corr. DeLaval TF 360

<b>1310155</b>	Milk claw   corr. DeLaval TF 360
<b>1310345</b>	Bowl   complete   corr. DeLaval 964.800-96
<b>1310148</b>	Bowl   only   corr. DeLaval 905.609-02
<b>1308158</b>	S/S Claw Manifold   corr. DeLaval 968.227-80
<b>1307323</b>	Gasket   corr. for DeLaval 968.130-01
<b>1310243</b>	Protecting gasket   corr. DeLaval 905.781-01
<b>1300002</b>	Claw valve   corr. DeLaval 960.207-01
<b>1310151</b>	Shut off valve
<b>1310152</b>	Air vent
<b>1308119</b>	Central outlet   corr. DeLaval 998.261-01
<b>1310149</b>	Spring
<b>1311907</b>	Hook   ACR   corr. DeLaval 907.484-80



## Milk claw without shut off corr. DeLaval TF 360

<b>1310199</b>	Milk claw   without shut off   corr. DeLaval TF 360
<b>1310112</b>	Bowl   only   without shut off   corr. DeLaval 905.609-82
<b>1308158</b>	S/S Claw Manifold   corr. DeLaval 968.227-80
<b>1307323</b>	Gasket   corr. DeLaval 968.130-01
<b>1310243</b>	Protecting gasket   corr. DeLaval 905.781-01
<b>1310152</b>	Air vent
<b>1308119</b>	Central outlet   corr. DeLaval 998.261-01
<b>1310149</b>	Spring
<b>1311907</b>	Hook   ACR   corr. DeLaval 907.484-80



## Milk claw corr. DeLaval MC3

<b>1311850</b>	Milk claw   250 cc   corr. DeLaval MC3 927.854-83
<b>1311815</b>	Bowl   complete   250 cc   corr. DeLaval MC3 955.645-01
<b>1311810</b>	Bowl   only   250 cc   corr. DeLaval MC3 955.645-02
<b>1311811</b>	Gasket   corr. DeLaval MC3 901.184-01
<b>1311813</b>	Claw valve   corr. DeLaval MC3 960.207-01
<b>1311814</b>	Bumper   corr. DeLaval MC3 985.887-01
<b>1311812</b>	Shut off valve   corr. DeLaval MC3 998.332-80
<b>1311817</b>	Air distributor   corr. DeLaval MC3 955.850-2



## Bowl corr. DeLaval Flo-Tek MK2

<b>1301713</b>	Bowl   complete   330 cc
<b>1307242</b>	Gasket
<b>1308106</b>	Claw valve
<b>1308105</b>	Bumper
<b>1307241</b>	Shut off valve



## Bowl corr. DeLaval Harmony + MCG TF 450

<b>1311710</b>	Bowl   only   corr. DeLaval Harmony + 905.315-02
<b>1311720</b>	Gasket   hexagon   corr. DeLaval Harmony + 905.291-01





## Support for service arm corr. DeLaval

**1307233** Support | service arm | black | plastic | corr. DeLaval 985.255-01



## Milk claw corr. DeLaval Germania

**1310773** S/S claw | ¾" (19 mm) | standard | corr. DeLaval Germania

**1310768** S/S claw | ¾" (19 mm) | parallel | corr. DeLaval Germania

**1310769** Glass | corr. DeLaval Germania and California

**1310770** Gasket | white | corr. DeLaval Germania and California

**1310774** T-piece | air | left/right | 9/32" - 7,15 mm | corr. DeLaval Germania

**1310775** T-piece | air | back/front | 7,15 mm | corr. DeLaval Germania

**1310776** T-piece | air | back/front | 6,35 mm | corr. DeLaval IBA

**1310772** Plug | corr. DeLaval Germania

**1310771** Spring | for glass | corr. DeLaval Germania and California



## Claw rubber corr. DeLaval

**1301364** Claw rubber | with tear | corr. DeLaval 953.344-80

**1301365** Claw rubber | without tear | corr. DeLaval 959.019-81



## Gasket corr. DeLaval

**1330147** Gasket | corr. DeLaval HCC145 / HP200 960.521-01



## Claw bowl corr. Manus

**1307271** Claw bowl | complete | 400 cc | outlet Ø 16 x 20 mm

**1307272** Claw bowl | only | 400 cc | outlet Ø 16 x 20 mm

**1307270** Gasket

**1300002** Claw valve | corr. DeLaval 960.207-01

**1300009** Shut off valve | long stem | 34 mm

**1300045** Bumper



## Claw bowl corr. Manus Optimum

<b>1311075</b>	Claw bowl   complete   corr.Manus 955.999-01
<b>1311078</b>	Claw bowl   only
<b>1311071</b>	Gasket
<b>1300002</b>	Claw valve
<b>1311079</b>	Bumper
<b>1311070</b>	Shut off valve



## Milk claw corr. Fullwood Freeway

<b>1311065</b>	Milk claw   350 cc   2:2   sideways milking   straight nipples
<b>1307320</b>	Milk claw   350 cc   2:2   sideways milking   angled nipples
<b>1300075</b>	Milk claw   350 cc   4:1   sideways milking   angled nipples
<b>1310713</b>	Claw bowl   only   sideways milking   straight nipples   corr. Fullwood Freeway 214-673
<b>1310714</b>	Claw bowl   only   backward milking   straight nipples   corr. Fullwood Freeway 215-035
<b>1300080</b>	Claw bowl   only   sideways milking   angled nipples   corr. Fullwood Freeway 214-159
<b>1310716</b>	Claw bowl   only   backward milking   angled nipples   corr. Fullwood Freeway 215-036
<b>1300082</b>	S/S lower part
<b>1300081</b>	Gasket   Ø 95 mm
<b>1300083</b>	Air distributor   2:2   corr. Fullwood Tru-flow / Freeway
<b>1300084</b>	Air distributor   4:1   corr. Fullwood Tru-Flow / Freeway
<b>1300079</b>	Air distributor   lower part
<b>1300078</b>	Hook
<b>1300077</b>	Bold



## Claw bowl corr. Fullwood Clearflow

<b>1311620</b>	Claw bowl   only   without hole for shut-off   long axle   corr. Fullwood Clearflow 721-748
<b>1311640</b>	Claw bowl   only   with hole for shut-off   long axle   corr. Fullwood Clearflow 721-742
<b>1311623</b>	Gasket   corr. Fullwood Clearflow F21-740
<b>1311636</b>	Lock up cap   corr. Fullwood Clearflow F21-502
<b>1311663</b>	Bumper   corr. Fullwood Clearflow F021-533
<b>1311656</b>	S/S axle   corr. Fullwood Clearflow F21-633
<b>1311624</b>	Shut off valve   corr. Fullwood Clearflow F21-501
<b>1311637</b>	S/S nut for shut off   corr. Fullwood Clearflow F21-514
<b>1311653</b>	Nylon ring   corr. Fullwood Clearflow F21-644
<b>1311631</b>	S/S circlip   corr. Fullwood Clearflow F02-933



## Protecting gasket corr. Fullwood

<b>1308036</b>	Protecting gasket   Ø 80 mm
----------------	-----------------------------



## Claw bowl corr. Miele

<b>1311665</b>	Claw bowl   only   corr. Miele 7720-1845-110
<b>1307324</b>	Gasket   corr. Miele 7720-1039-420



## Gasket corr. Gascoigne Melotte

<b>1309902</b>	Gasket   corr. Gascoigne Melotte Isolac D382.741
----------------	--



## Minicupring corr. Gascoigne Melotte

<b>1301393</b>	Minicupring   rubber   corr. Gascoigne Melotte T242.121
----------------	---



## Milk claw corr. Westfalia Classic 300

<b>1309612</b>	Milk claw   300 cc   with shut off valve   corr. Westfalia Classic 300 7021.2620.300
<b>1310485</b>	Milk claw   300 cc   with shut off valve   straight pipes   corr. Westfalia Classic 300
<b>1309613</b>	Claw bowl   complete   with shut off valve   corr. Westfalia Classic 300 7021.2621.090
<b>1309614</b>	Claw bowl   only   with hole for shut off
<b>1309621</b>	S/S Claw manifold
<b>1310407</b>	S/S Claw manifold   straight pipes
<b>1309623</b>	Gasket
<b>1309624</b>	Claw valve
<b>1309625</b>	Bumper
<b>1309622</b>	Shut off valve
<b>1309627</b>	Holder
<b>1309619</b>	Air distributor
<b>1309620</b>	S/S hook
<b>1309626</b>	Intermediate plate
<b>1309628</b>	S/S bold   M6 x 110 mm
<b>1300109</b>	O-ring   corr. Westfalia Magnum and Classic 300
<b>1309618</b>	Screw nut



## Milk claw without shut off corr. Westfalia Classic 300

<b>1309615</b>	Milk claw   300 cc   without shut off valve   corr. Westfalia 7021-2620-290
<b>1310406</b>	Milk claw   300 cc   without shut off valve   straight pipes
<b>1309616</b>	Claw bowl   complete   without shut off valve   corr. Westfalia Classic 300 7021.2621.080
<b>1309617</b>	Claw bowl   only   without hole for shut off
<b>1309621</b>	S/S Claw manifold
<b>1310407</b>	S/S Claw manifold   straight pipes
<b>1309623</b>	Gasket
<b>1309625</b>	Bumper
<b>1309619</b>	Air distributor
<b>1309620</b>	S/S hook
<b>1309626</b>	Intermediate plate
<b>1309629</b>	Bold   M6 x 110 mm
<b>1300109</b>	O-ring   corr. Westfalia Magnum and Classic 300
<b>1309618</b>	Screw nut



## Milk claw corr. Westfalia Classic 300 EVO

<b>1311470</b>	Milk claw   300 cc   with shut off valve
<b>1309613</b>	Claw bowl   complete   with shut off valve
<b>1309614</b>	Claw bowl   only   with hole for shut off
<b>1311410</b>	S/S Claw manifold
<b>1309623</b>	Gasket
<b>1309624</b>	Claw valve
<b>1309625</b>	Bumper
<b>1309622</b>	Shut off valve
<b>1309627</b>	Holder
<b>1309619</b>	Air distributor
<b>1309620</b>	S/S hook
<b>1309626</b>	Intermediate plate
<b>1309628</b>	S/S bold   M6 x 110 mm
<b>1300109</b>	O-ring   corr. Westfalia Magnum and Classic 300
<b>1309618</b>	Screw nut



## Milk claw without shut off corr. Westfalia Classic 300 EVO

<b>1311460</b>	Milk claw   300 cc   without shut off valve
<b>1309616</b>	Claw bowl   complete   without shut off valve   corr. Westfalia Classic 300 7021.2621.080
<b>1309617</b>	Claw bowl   only   without hole for shut off
<b>1311410</b>	S/S Claw manifold
<b>1309623</b>	Gasket
<b>1309625</b>	Bumper
<b>1309619</b>	Air distributor
<b>1309620</b>	S/S hook
<b>1309626</b>	Intermediate plate
<b>1309629</b>	Bold   M6 x110 mm
<b>1300109</b>	O-ring   corr. Westfalia Magnum and Classic 300
<b>1309618</b>	Screw nut



## Claw bowl 150 cc corr. Westfalia

1300021	Claw bowl   complete   150 cc   outlet Ø 16 mm
1300020	Claw bowl   only   150 cc   outlet Ø 16 mm
1300017	Gasket
1300002	Claw valve
1300025	Bumper
1308227	Shut off valve   short stem 23 mm



## Claw bowl 200 cc corr. Westfalia

1311830	Claw bowl   complete   200 cc   corr. Westfalia 7021-2447-000
1311820	Claw bowl   only   200 cc   corr. Westfalia 7021-2617-020



## Claw bowl corr. Westfalia Flo-Tek MK2

1301714	Claw bowl   complete   330 cc
1307242	Gasket
1300002	Claw valve
1308105	Bumper
1307241	Shut off valve



## Parts for milk claws corr. Westfalia

1300105	Gasket   Ø 120 x 5,33 mm   for milk claw 450 cc
1300110	Bumper   for milk claw 450 cc   corr. Westfalia Magnum



## Orbiter

<b>1307273</b>	Orbiter milk claw   240 cc   plastic   outlet Ø 14 mm
<b>1309514</b>	Orbiter claw bowl   complete   240 cc   outlet Ø 14 mm
<b>1308236</b>	Orbiter claw bowl   only   240 cc   outlet Ø 14 mm
<b>1308244</b>	Orbiter milk claw   240 cc   plastic   outlet Ø 16 mm
<b>1309513</b>	Orbiter claw bowl   complete   240 cc   outlet Ø 16 mm
<b>1308249</b>	Orbiter claw bowl   only   240 cc   outlet Ø 16 mm
<b>1309538</b>	Orbiter claw bowl   only   250 cc   with vent for shut off   outlet Ø 14 mm
<b>1309539</b>	Orbiter claw bowl   only   250 cc   with vent for shut off   outlet Ø 16 mm
<b>1309537</b>	Orbiter claw bowl   only   250 cc   without vent for shut off   outlet Ø 16 mm
<b>1307275</b>	Orbiter claw bowl   complete   340 cc   with shut off
<b>1309516</b>	Orbiter claw bowl   complete   340 cc   outlet Ø 16 mm
<b>1309517</b>	Orbiter milk claw   340 cc   left/right   ACR   outlet Ø 13,5 x 9,5 mm
<b>1307274</b>	Orbiter milk claw   350 cc   left/right
<b>1308326</b>	Orbiter milk claw   350 cc   back/front
	<i>Other parts on request</i>



## NuPulse

<b>1310676</b>	Milk claw   standard   corr. 1000INP
<b>1314200</b>	Claw bowl   only   standard
<b>1314254</b>	Gasket
<b>1314260</b>	Protection ring
<b>1314210</b>	Middle part
<b>1314220</b>	Diaphragm   complete
<b>1314230</b>	Airfilter
<b>1314250</b>	Coil
<b>1314240</b>	Housing   for coil
<b>1314253</b>	Gasket   for housing   for coil
<b>1314255</b>	Shut off   for coil
<b>1314256</b>	Clip   for coil
<b>1314285</b>	Hook
<b>1314265</b>	Spring   for pulsator
<b>1314270</b>	Protection cover
<b>1314275</b>	Plug
<b>1314280</b>	MLX claw bowl   only
<b>1314290</b>	MLX middle part
<b>1314154</b>	FulFlo MLX part   for parallel parlor





<b>1314132</b>	FulFlo middle part   standard
<b>1307265</b>	O-ring   for coil
<b>1307266</b>	O-ring   for middle part

## Liners corr. Boumatic

<b>1308419</b>	Liner   21 mm - 11 mm   corr. Boumatic R-C1
<b>1307452</b>	Liner   23 mm - 11 mm   corr. Boumatic 8506718 en 8506752
<b>1308418</b>	Liner   23 mm - 11 mm   corr. Boumatic DK1X
<b>1308405</b>	Liner   23 mm - 11 mm   with air valve   corr. Boumatic DK1X
<b>1311039</b>	Liner   21 mm - 11 mm   corr. Boumatic DK1X
<b>1312023</b>	Liner   20 mm - 12 mm   corr. Boumatic R1EX
<b>1312028</b>	Liner   24 mm - 11 mm   corr. Boumatic DKFM
<b>1312430</b>	Liner   23 mm - 10,5 mm   corr. Boumatic Magnum 400MX
<b>1312432</b>	Liner   23 mm - 10,5 mm   with air valve   corr. Boumatic Magnum 400MX
<b>1312435</b>	Liner   25 mm - 11 mm   corr. Boumatic Flex 60
<b>1312436</b>	Liner   25 mm - 11 mm   with air valve   corr. Boumatic Flex 60



## Liners corr. Dairymaster

<b>1312440</b>	Liner   22,5 mm - 8,5 mm   corr. Dairymaster 916S
<b>1312448</b>	Liner   23 mm - 9 mm   corr. Dairymaster 916SL
<b>1312444</b>	Liner   22 mm - 8,5 mm   corr. Dairymaster 916SL



## Liners corr. DeLaval

<b>1307448</b>	Liner   24 mm - 8 mm   corr. DeLaval 960.000-01
<b>1309542</b>	Liner   24 mm - 9,5 mm   corr. DeLaval 960.000-01
<b>1310646</b>	Liner   24 mm - 9,5 mm   with star   corr. DeLaval 960.000-01
<b>1307446</b>	Liner   27 mm - 8 mm   corr. DeLaval 960.000-01
<b>1310353</b>	Liner   22,5 mm - 9 mm   silicone   corr. DeLaval 960.000-01
<b>1301952</b>	Liner   22,5 mm - 8 mm   silicone   corr. DeLaval 960.000-01
<b>1310645</b>	Liner   24 mm - 8 mm   with star   corr. DeLaval 960.000-02
<b>1301681</b>	Liner   24 mm - 8,7 mm   corr. DeLaval 960.001-02
<b>1308172</b>	Liner   25 mm - 22 mm   corr. DeLaval 960.007-02
<b>1307442</b>	Liner   27 mm - 22,5 mm   corr. DeLaval 960.008-01
<b>1307443</b>	Liner   20 mm - 8 mm   corr. DeLaval 727537-01 and 928.178-01
<b>1312039</b>	Liner   25 mm - 9 mm   with star   corr. DeLaval 960.119



<b>1301734</b>	Liner		22 mm - 8 mm		corr. DeLaval 960.016-01
<b>1301165</b>	Liner		24 mm - 8 mm		corr. DeLaval 960.016-01
<b>1310251</b>	Liner		22 mm - 9,5 mm		silicone   corr. DeLaval 960.016-01
<b>1301732</b>	Liner		22 mm - 8 mm		silicone   corr. DeLaval 960.016-01
<b>1308217</b>	Liner		22 mm - 8 mm		with star   corr. DeLaval 960.016-83
<b>1310358</b>	Liner		22 mm - 9,5 mm		with star   corr. DeLaval 960.016-83
<b>1309878</b>	Liner		24 mm - 8 mm		with star   corr. DeLaval 960.016-83
<b>1308216</b>	Liner		24 mm - 9 mm		with star   corr. DeLaval 960.016-83
<b>1310583</b>	Liner		24 mm - 9,5 mm		with star   corr. DeLaval 960.016-83
<b>1301166</b>	Liner		27 mm - 8 mm		corr. DeLaval 960.017-01
<b>1310587</b>	Liner		24 mm - 8,5 mm		silicone   corr. DeLaval 960.017-01
<b>1310584</b>	Liner		24 mm - 8 mm		corr. DeLaval 960.017-02
<b>1307447</b>	Liner		24 mm - 8,6 mm		corr. DeLaval 960.017-02
<b>1310586</b>	Liner		24 mm - 9,5 mm		corr. DeLaval 960.017-02
<b>1307450</b>	Liner		23 mm - 20 mm		corr. DeLaval 960.036-01
<b>1312030</b>	Liner		23 mm - 20 mm		silicone   corr. DeLaval 960.036-01
<b>1310653</b>	Liner		24 mm - 14,5 mm		corr. DeLaval 960.037-02
<b>1310654</b>	Liner		27 mm - 14,5 mm		corr. DeLaval 960.037-01
<b>1312060</b>	Liner		20 mm - 20 mm		corr. DeLaval 964.007-01
<b>1312020</b>	Liner		20 mm - 20 mm		silicone   corr. DeLaval 964.007-01
<b>1312032</b>	Liner		24 mm - 11 mm		corr. DeLaval 928.328-01
<b>1312033</b>	Liner		24 mm - 11 mm		silicone   corr. DeLaval 928.328-01
<b>1312067</b>	Liner		20 mm - 20 mm		corr. DeLaval 999.004-01
<b>1312055</b>	Liner		18 mm - 20 mm		corr. DeLaval 999.006-01
<b>1312070</b>	Liner		20 mm - 14 mm		corr. DeLaval DL2100
<b>1312066</b>	Liner		22 mm - 18,5 mm		corr. DeLaval 964.008-01
<b>1310359</b>	Liner		20 mm - 20 mm		corr. DeLaval 999.007-03
<b>1309711</b>	Liner		20 mm - 20 mm		corr. DeLaval 999.007-01
<b>1310360</b>	Liner		22 mm - 20 mm		345 mm lang   corr. DeLaval 999.008-01
<b>1310361</b>	Liner		22 mm - 20 mm		315 mm lang   corr. DeLaval 999.008-01 en 964.008-01
<b>1301174</b>	Liner		20 mm - 20 mm		310 mm length   corr. DeLaval 999.009-01
<b>1301167</b>	Liner		20 mm - 20 mm		315 mm length   corr. DeLaval 999.009-01
<b>1301682</b>	Liner		20 mm - 20 mm		315 mm length   silicone   corr. DeLaval 999.009-01
<b>1312034</b>	Liner		22 mm - 11 mm		corr. DeLaval 990.666-01 and 906.836-01
<b>1312036</b>	Liner		24 mm - 11 mm		corr. DeLaval 990.777-01 and 906.836-01
<b>1312038</b>	Liner		20 mm - 26 mm		165 mm length   corr. DeLaval VMS 927.259-01
<b>1312035</b>	Liner		20 mm - 14 mm		corr. DeLaval Triangular 869.407-01

## Liners corr. Fullwood

<b>1308142</b>	Liner		20 mm - 8 mm		corr. Fullwood 20114
<b>1301934</b>	Liner		22 mm - 17 mm		corr. Fullwood 20112
<b>1307566</b>	Liner		22,5 mm - 9,5 mm		corr. Fullwood 20138
<b>1301680</b>	Liner		22,5 mm - 8 mm		corr. Fullwood SL2 CTF 20137
<b>1309918</b>	Liner		22,5 mm - 9,5 mm		corr. Fullwood SL2 CTF WT 20138
<b>1307460</b>	Liner		24 mm - 17 mm		corr. Fullwood SL1
<b>1307464</b>	Liner		23 mm - 8 mm		corr. Fullwood SL2 CT 20134
<b>1308422</b>	Liner		23 mm - 9,5 mm		corr. Fullwood 20134
<b>1308338</b>	Liner		21 mm - 8,5 mm		corr. Fullwood 20146
<b>1307459</b>	Liner		22 mm - 11 mm		corr. Fullwood 20154 and 20168WT
<b>1301896</b>	Liner		23 mm - 8,5 mm		corr. Fullwood 20167
<b>1308420</b>	Liner		23 mm - 10 mm		corr. Fullwood 20168
<b>1308421</b>	Liner		20 mm - 10 mm		corr. Fullwood 20169
<b>1307564</b>	Liner		25 mm - 8 mm		corr. Fullwood 20215
<b>1310279</b>	Liner		25 mm - 9,5 mm		corr. Fullwood 20215
<b>1307565</b>	Liner		22,5 mm - 8 mm		corr. Fullwood 20227
<b>1309541</b>	Liner		22,5 mm - 9,5 mm		corr. Fullwood 20227



## Liners corr. Gascoigne Melotte

<b>1310370</b>	Liner		23 mm - 8 mm		corr. Gascoigne Melotte MK2 381981
<b>1310371</b>	Liner		23 mm - 9,5 mm		corr. Gascoigne Melotte Mk2 381981
<b>1307465</b>	Liner		24 mm - 8 mm		corr. Gascoigne Melotte MK2 278720
<b>1310369</b>	Liner		24 mm - 9,5 mm		corr. Gascoigne Melotte MK2 278720
<b>1307466</b>	Liner		25 mm - 8 mm		corr. Gascoigne Melotte MK2
<b>1312075</b>	Liner		27 mm - 8 mm		corr. Gascoigne Melotte MK2
<b>1309530</b>	Liner		24 mm - 8,5 mm		corr. Gascoigne Melotte 381987
<b>1307469</b>	Liner		24 mm - 8 mm		corr. Gascoigne Melotte MK3 H278720 flex
<b>1301937</b>	Liner		20 mm - 8 mm		corr. Gascoigne Melotte 1010
<b>1309889</b>	Liner		23 mm - 8 mm		corr. Gascoigne Melotte 1030
<b>1310788</b>	Liner		23 mm - 9,5 mm		corr. Gascoigne Melotte 381922
<b>1301903</b>	Liner		24 mm - 10 mm		corr. Gascoigne Melotte 381985
<b>1308366</b>	Liner		21 mm - 10 mm		corr. Gascoigne Melotte 381986
<b>1307485</b>	Liner		24 mm - 10 mm		corr. Gascoigne Melotte 381988
<b>1307468</b>	Liner		22 mm - 11 mm		corr. Gascoigne Melotte 381989
<b>1308337</b>	Liner		23 mm - 10 mm		corr. Gascoigne Melotte 381991
<b>1307483</b>	Liner		24 mm - 10 mm		corr. Gascoigne Melotte 381995
<b>1310377</b>	Liner		24 mm - 8 mm		corr. Gascoigne Melotte 381416
<b>1307484</b>	Liner		24 mm - 8 mm		corr. Gascoigne Melotte T24/L 381416



<b>1310378</b>	Liner   22 mm - 8 mm   silicone   corr. Gascoigne Melotte T24/L 381416
<b>1307481</b>	Liner   28 mm - 8 mm   corr. Gascoigne Melotte T24/C 381130
<b>1307480</b>	Liner   28 mm - 8 mm   corr. Gascoigne Melotte T54/L
<b>1307482</b>	Liner   28 mm - 8 mm   corr. Gascoigne Melotte T54/C 381169
<b>1307467</b>	Liner   22 mm - 8 mm   corr. Gascoigne Melotte MK5

## Liners corr. Impulsa

<b>1312043</b>	Liner   23 mm - 10 mm   corr. Impulsa NW23
<b>1312041</b>	Liner   23 mm - 19 mm   corr. Impulsa NW23
<b>1312044</b>	Liner   25 mm - 10 mm   corr. Impulsa NW25
<b>1312042</b>	Liner   25 mm - 19 mm   corr. Impulsa NW25



## Liners corr. Manus

<b>1310640</b>	Liner   24 mm - 10 mm   corr. Manus 901.029-01
<b>1307477</b>	Liner   23 mm - 10 mm   corr. Manus 901.031-80
<b>1310647</b>	Liner   23 mm - 9 mm   corr. Manus 901.163-01
<b>1310808</b>	Liner   24 mm - 10 mm   corr. Manus 901.197-01
<b>1301170</b>	Liner   24 mm - 9 mm   corr. Manus 955.390-80
<b>1307568</b>	Liner   24 mm - 9 mm   corr. Manus 955507
<b>1307476</b>	Liner   23 mm - 9 mm   corr. Manus 955875
<b>1307474</b>	Liner   23 mm - 10 mm   corr. Manus 955.897-01
<b>1307471</b>	Liner   25 mm - 8 mm   corr. Manus 957706
<b>1307472</b>	Liner   25 mm - 8 mm   corr. Manus 958123
<b>1307470</b>	Liner   25 mm - 24 mm   corr. Manus 957713
<b>1307473</b>	Liner   26 mm - 23 mm   corr. Manus 957716



## Liners corr. Miele

<b>1308404</b>	Liner		22 mm - 14 mm		corr. Miele 68278
<b>1307551</b>	Liner		24 mm - 14 mm		corr. Miele 68278,
<b>1301950</b>	Liner		29,5 mm - 14 mm		corr. Miele 68278
<b>1307552</b>	Liner		24 mm - 14 mm		silicone   corr. Miele 68278
<b>1307553</b>	Liner		24 mm - 9,5 mm		corr. Miele Monobloc
<b>1312057</b>	Liner		25 mm - 18 mm		corr. Miele 23178-01



## Liners corr. Lely

<b>1312350</b>	Liner		19 mm		green   silicone   corr. Lely
<b>1312340</b>	Liner		21,5 mm		green   silicone   corr. Lely



## Liners corr. SAC

<b>1310592</b>	Liner		22 mm - 8 mm		corr. SAC 252.15.004
<b>1301168</b>	Liner		25 mm - 8 mm		corr. SAC 252.15.004
<b>1307453</b>	Liner		20 mm - 8 mm		corr. SAC 252.15.007
<b>1310381</b>	Liner		22 mm - 8 mm		corr. SAC 252.15.007
<b>1309785</b>	Liner		21 mm - 8 mm		silicone   corr. SAC 252.15.007
<b>1301169</b>	Liner		22 mm - 14 mm		short head   corr. SAC 252.15.010
<b>1307455</b>	Liner		22 mm - 14 mm		corr. SAC 252.15.010
<b>1308235</b>	Liner		22 mm - 14 mm		silicone   corr. SAC 252.15.010
<b>1307456</b>	Liner		20 mm - 14 mm		short head   corr. SAC 252.15.012
<b>1308341</b>	Liner		20 mm - 14 mm		corr. SAC 252.15.012
<b>1309786</b>	Liner		20 mm - 14 mm		silicone   corr. SAC 252.15.012
<b>1311342</b>	Liner		24 mm - 14 mm		corr. SAC 252.15.013
<b>1310763</b>	Liner		20 mm - 13,5 mm		corr. SAC 252.15.020
<b>1310677</b>	Liner		20 mm - 13,5 mm		corr. SAC 252.15.022



## Liners corr. Strangko

<b>1310596</b>	Liner   20 mm - 9 mm   corr. Strangko 3426009
<b>1301963</b>	Liner   22 mm - 9 mm   corr. Strangko 3426010-01
<b>1309782</b>	Liner   22 mm - 10 mm   corr. Strangko 3426018
<b>1309783</b>	Liner   22 mm - 11 mm   silicone   corr. Strangko 3426018
<b>1312054</b>	Liner   20 mm - 10 mm   corr. Strangko 3426008
<b>1312064</b>	Liner   24 mm - 10 mm   corr. Strangko 3426024
<b>1310594</b>	Liner   20 mm - 9 mm   corr. Strangko 3423005
<b>1307572</b>	Liner   20 mm - 9 mm   corr. Strangko 3423007
<b>1310595</b>	Liner   23 mm   corr. Strangko 3423007
<b>1312065</b>	Liner   20 mm - 10 mm   corr. Strangko 3426009



## Liners corr. Surge

<b>1301907</b>	Liner   22 mm - 10 mm   corr. Surge CL5 10025
<b>1310383</b>	Liner   22 mm - 10 mm   corr. Surge 10029
<b>1307489</b>	Liner   24 mm   corr. Surge type III 10040
<b>1307491</b>	Liner   20 mm - 10 mm   corr. Surge 10048
<b>1307490</b>	Liner   23 mm - 10 mm   corr. Surge type V 10067
<b>1310597</b>	Liner   23 mm - 10 mm   corr. Surge 10067
<b>1307492</b>	Liner   24 mm - 8 mm   corr. Surge 10037



## Liners corr. Westfalia

<b>1307557</b>	Liner   23 mm - 8 mm   corr. Westfalia 7021.2725.030
<b>1312040</b>	Liner   22 mm - 10 mm   silicone   corr. Westfalia 7021.2725.030
<b>1310598</b>	Liner   21 mm - 19 mm   corr. Westfalia 7021.2725.040
<b>1301740</b>	Liner   23 mm - 19 mm   corr. Westfalia 7021.2725.110
<b>1310384</b>	Liner   24 mm - 19 mm   corr. Westfalia 7023.2725.110
<b>1301741</b>	Liner   22 mm - 19,5 mm   silicone   corr. Westfalia 7021.2725.110
<b>1310599</b>	Liner   25 mm - 9 mm   corr. Westfalia 7022.2725.010
<b>1309731</b>	Liner   24 mm - 17 mm   silicone   corr. Westfalia 7027.2725.010
<b>1312048</b>	Liner   23 mm - 19 mm   green   silicone   corr. Westfalia 7029,2725.010
<b>1307556</b>	Liner   23 mm - 19 mm   corr. Westfalia 7021.2725.220 and 7021.2909.160
<b>1307559</b>	Liner   23 mm - 19 mm   corr. Westfalia 7021.2725.230
<b>1312080</b>	Liner   21 mm - 19 mm   corr. Westfalia 7021.2725.350
<b>1307561</b>	Liner   25 mm - 19 mm   corr. Westfalia 7022.2725.130



<b>1309531</b>	Liner		22,5 mm - 10 mm		corr. Westfalia 7021.2725.130
<b>1307555</b>	Liner		24 mm - 19 mm		corr. Westfalia 7022.2725.150
<b>1307560</b>	Liner		24 mm - 19,5 mm		silicone   corr. Westfalia 7022.2725.150
<b>1307558</b>	Liner		22 mm - 19 mm		corr. Westfalia 4023.2725.060
<b>1310351</b>	Liner		23 mm - 19 mm		corr. Westfalia 7023.2725.100/120/070
<b>1310385</b>	Liner		25 mm - 17 mm		silicone   corr. Westfalia 7027.2725.020
<b>1312345</b>	Liner		21 mm -15 mm		green   silicone   corr. Westfalia 7029.2725.000
<b>1307571</b>	Liner		22 mm - 8 mm		corr. Westfalia 7021.2725.070
<b>1310137</b>	Liner		23 mm - 10 mm		corr. Westfalia 7021.2725.240
<b>1310138</b>	Liner		22,5 mm - 10 mm		corr. Westfalia 7021.2725.270

## Several Liners

<b>1310648</b>	Liner		22 mm - 14,5 mm		corr. Meltec 7720-2522-680
<b>1307488</b>	Liner		24 mm - 8,5 mm		corr. National
<b>1307574</b>	Liner		22 mm - 8 mm		corr. Hosier
<b>1309832</b>	Liner		25 mm - 8,8 mm		corr. ADM
<b>1312046</b>	Liner		22 mm - 10 mm		corr. Tecnozo0 005/AC
<b>1310792</b>	Liner		20 mm - 8,5 mm		corr. Orion EUR OR1
<b>1310795</b>	Liner		20 mm - 10 mm		corr. Orion N3B



## Liners corr. Milkrite

<b>1312650</b>	Liner		20 mm - 13 mm		triangle   corr. Milkrite IP11U
<b>1312660</b>	Liner		20 mm - 13 mm		triangle   with air valve   corr. Milkrite IP11U
<b>1312610</b>	Liner		22,5 mm - 10 mm		triangle   corr. Milkrite IP10U
<b>1312620</b>	Liner		22,5 mm - 10 mm		triangle   with air valve   corr. Milkrite IP10U
<b>1312630</b>	Liner		22,5 mm - 10 mm		triangle   corr. Milkrite IP15U
<b>1312640</b>	Liner		22,5 mm - 10 mm		triangle   with air valve   corr. Milkrite IP15U
<b>1312670</b>	Liner		22,5 mm - 12,5 mm		triangle   corr. Milkrite IP13U
<b>1312680</b>	Liner		22,5 mm - 12,5 mm		triangle   with air valve   corr. Milkrite IP13U





## Liners Westfalia (original)

<b>1312310</b>	Liner   original   silicone   green   Westfalia Classic Pro D21-27 7029-2725-000
<b>1312315</b>	Liner   original   silicone   green   Westfalia Classic Pro D21-24 7029-2725-010
<b>1312317</b>	Liner   original   silicone   green   Westfalia Classic Pro D23-29 7029-2725-020
<b>1312319</b>	Liner   original   silicone   green   Westfalia Classic Pro D19-25 7029-2725-030
<b>1312321</b>	Liner   original   silicone   green   Westfalia Classic Pro D20-26 7029-2725-150
<b>1312330</b>	Liner   original   silicone   yellow   Westfalia Stimulor M22 7027- 2725-000
<b>1312332</b>	Liner   original   silicone   yellow   Westfalia Stimulor M33 7027- 2725-010
<b>1312334</b>	Liner   original   silicone   yellow   Westfalia Stimulor S21 7027- 2725-152
<i>Other original liners available on request</i>	



## Teat cup shell corr. Boumatic 8517327

<b>1308152</b>	Teat cup shell   S/S   corr. Boumatic   outer diameter: 45 mm   length: 140,5 mm   hole: 19 mm   pipe: 8 mm   wall thickness: 1,5 mm   weight: +/- 185 gram
----------------	---



## Teat cup shells corr. DeLaval

<b>1311450</b>	Teat cup shell   plastic   S/S ring   corr. DeLaval 964.420-80
<b>1301133</b>	Teat cup shell   S/S   corr. DeLaval 960.550-82   outer diameter: 45 mm   length: 155 mm   hole: 17 mm   pipe: 10 mm   wall thickness: 2,5 mm   weight: +/- 400 gram
<b>1310298</b>	Teat cup shell   S/S   corr. DeLaval 960.550-82   outer diameter: 45 mm   length: 155 mm   hole: 17 mm   pipe: 10 mm   wall thickness: 1,4 mm   weight: +/- 250 gram
<b>1301137</b>	Teat cup shell   S/S   corr. DeLaval 960.550-80   outer diameter: 45 mm   length: 140 mm   hole: 20 mm   pipe: 10 mm   wall thickness: 2,5 mm   weight: +/- 350 gram
<b>1301134</b>	Teat cup shell   S/S   corr. DeLaval 960.550-80   outer diameter: 45 mm   length: 140 mm   hole: 20 mm   pipe: 10 mm   wall thickness: 1,25 mm   weight: +/- 200 gram
<b>1310263</b>	Teat cup shell   S/S   corr. DeLaval 960.550-90   outer diameter: 44 mm   length: 148 mm   hole: 22 mm   pipe: 10 mm   wall thickness: 1,4 mm   weight: +/- 230 gram



## Teat cup shell corr. Surge

**1308136** Teat cup shell | S/S | corr. Surge Jetflow type | outer diameter: 43 mm | length: 139 mm | hole: 21 mm | pipe: 9 mm | wall thickness: 1,5 mm | weight: +/- 220 gram



## Teat cup shells corr. Westfalia

**1301132** Teat cup shell | S/S | corr. Westfalia 7021.2721.090 | outer diameter: 45 mm | length: 147 mm | hole: 27 mm | pipe: 10 mm | wall thickness: 2,5 mm | weight: +/- 385 gram

**1309852** Teat cup shell | S/S | corr. Westfalia 7021.2721.090 | outer diameter: 45 mm | length: 147 mm | hole: 27 mm | pipe: 10 mm | wall thickness: 1,4 mm | weight: +/- 230 gram



## Teat cup shell corr. Milkrite

**1312690** Teat cup shell | plastic | for triangle liners | corr. Milkrite  
*Other types of teat cup shells available on request*



## Adapters corr. Fullwood

**1301123** Adapter | liner | corr. Fullwood 20115

**1311412** Adapter | transparent | teat cup shell | corr. Fullwood F20-158

**1311414** O-ring | for adapter | corr. Fullwood F07-651

**1311419** Adapter | transparent | teat cup shell | corr. Fullwood F20-149



## Sight glass corr. DeLaval

**1301124** Sight glass | 65 x 7 x 20 mm | corr. DeLaval



## Sight glass corr. Fullwood

**1301121** Sight glass | 52 x 8 x 15 mm | with 2 lines | corr. Fullwood



## Sight glass corr. Manus

**1301120** Sight glass | 60 x 8 x 26 mm | corr. Manus



## Sight glass corr. Westfalia

**1301125** Sight glass | 51 x 8 x 16 mm | corr. Westfalia

**1307141** Sight glass | 14 mm | corr. Westfalia vacustop

**1307106** Sight glass | 16 mm | corr. Westfalia vacustop 7021-2188-050

**1311908** Sight glass | corr. Westfalia Stimulor 7021-2088-100

**1307145** Sight glass | 14 x 10 mm | corr. Westfalia 7021-2088-060

**1301706** Sight glass | 52 x 12 x 17 mm | corr. Westfalia



## Stop for liner

**1301350** Stop for liner | universal | black



## Stop for liner ISO

**1301353** Tepelvoeringstop | ISO | black

**1301354** Tepelvoeringstop | ISO | orange

**1301357** Tepelvoeringstop | ISO | orange | with eyelet



## Stop for liner

**1301351** Stop for liner | universal | black

**1301352** Stop for liner | universal | orange



## Stop for liner corr. DeLaval

**1330036** Stop for liner | blue | corr. DeLaval 956.803-01



Chapter 2

# TUBING AND ACCESSORIES

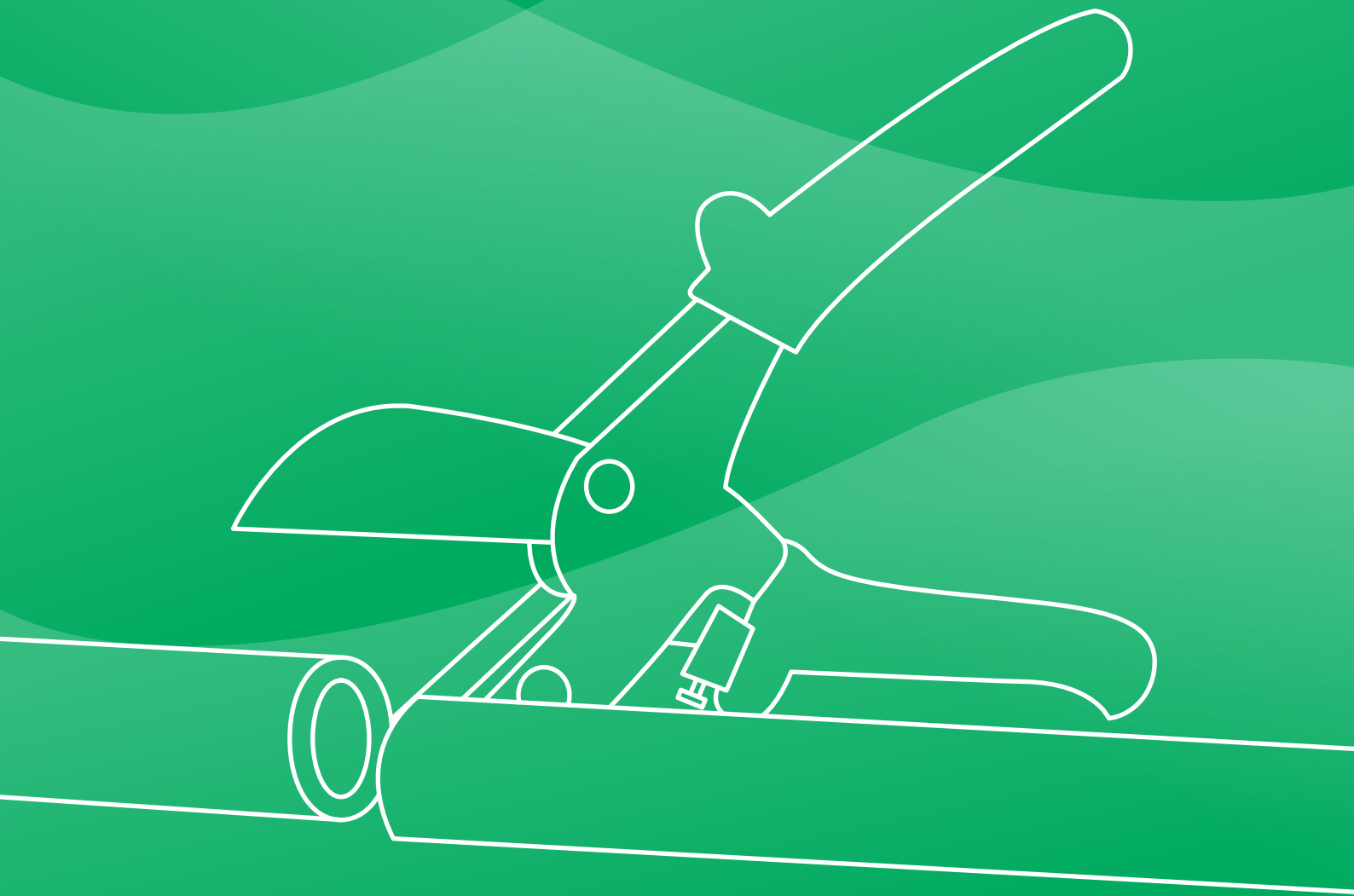

## Chapter 2 Tubing and accessories

PVC Milk tube blue line	P31
PVC Milk tube blue lines	P31
PVC Milk tube green line	P31
PVC Milk tube crystal clear	P31
PVC Milk tube transparent reinforced	P31
PVC Micky Mouse milk tube	P31
Silicone milk tube transparent	P32
Silicone milk tube transparent blue	P32
Silicone milk tube massive blue	P32
Silicone milk tube massive green	P32
Silicone milk tube Hysil	P33
Silicone Micky Mouse milk tube	P33
Rubber milk tube green line	P33
Rubber milk tube orange line	P33
Rubber milk tube blue line	P33
Rubber milk tube white line	P34
Rubber milk tube black	P34
Rubber Micky Mouse milk tube white line	P34
Milk tube short silicone corr. DeLaval	P34
Milk tube short rubber	P34
Milk tube short rubber conical	P35
Milk tube short rubber two sides ridges	P35
Milk tube short rubber corr. Westfalia	P35
Milk tube short rubber one side reinforced	P35
Milk tube short rubber reinforced conical	P35
Milk tube short rubber corr. DeLaval	P35
Milk tube short rubber corr. Meltec	P36
PVC pulsation tube single blue line	P36
PVC pulsation tube double blue	P36
PVC pulsation tube double blue line	P36
Silicone pulsation tube double white	P36
Silicone pulsation tube double massive green	P36
Silicone pulsation tube double blue	P36
Rubber pulsation tube double	P37
Rubber pulsation tube single orange line	P37
Rubber pulsation tube single red line	P37
Rubber pulsation tube single blue line	P37
Pulsation tube short rubber orange line	P37
Pulsation tube short rubber blue line	P37

Pulsation tube short rubber green line	P38
Pulsation tube short rubber red line	P38
Pulsation tube short rubber white line	P38
Pulsation tube short rubber reinforced	P38
Robot tube silicone corr. Westfalia	P38
Robot tube Duplo silicone corr. Lely	P39
Robot tube silicone corr. DeLaval	P39
Sleeve corr. Lely	P39
Robot tube short corr. DeLaval	P39
Milk transportation tube	P39
Suction- and pressure tube	P40
Water tube PVC MasterPlus	P40
Water tube Trix	P40
Water tube EPDM	P40
Washing machine tube	P41
Y-tube	P41
S/S shut off valve	P41
Diaphragm for shut off valve	P41
Plastic shut off valve	P41
S/S shut off valve small model	P41
Plastic shut off valve corr. DeLaval	P41
S/S pinch clamp	P42
Plastic pinch clamp	P42
S/S hose clamp	P42
Tube bundle ring rubber black	P42
Tube bundle ring rubber blue	P42
Tube bundle ring silicone	P43
Tube holder clip plastic	P43
Tube holder clip single plastic	P43
Tube holder clip plastic corr. Fullwood	P43
Tube scissor	P43
S/S spring	P43
Brush	P43
Swing arm	P44
Hose connector	P44
Pull discharger	P44
S/S tube connector	P44
Y-piece	P44
T-piece	P45
L-piece	P45
S/S Y-piece	P45

## PVC Milk tube blue line

<b>1300396</b>	PVC milk tube   14 x 23,6 mm   blue line   25 mtr/coil
<b>1300397</b>	PVC milk tube   15,9 x 25,5 mm   blue line   25 mtr/coil
<b>1300398</b>	PVC milk tube   19 x 32 mm   blue line   25 mtr/coil
<b>1300336</b>	PVC milk tube   25,4 x 38 mm   blue line   15 mtr/coil



## PVC Milk tube blue lines

<b>1311487</b>	PVC milk tube   12,7 x 21 mm   4 blue lines   30 mtr/coil
<b>1311480</b>	PVC milk tube   25 x 37 mm   4 blue lines   15 mtr/coil
<b>1311490</b>	PVC milk tube   30 x 43 mm   4 blue lines   15 mtr/coil



## PVC Milk tube green line

<b>1311010</b>	PVC milk tube   14 x 23,6 mm   green line   30 mtr/coil
----------------	---



## PVC Milk tube crystal clear

<b>0501503</b>	PVC milk tube   4 x 6 mm   crystal clear   100 mtr/coil
<b>0501507</b>	PVC milk tube   5 x 8 mm   crystal clear   100 mtr/coil
<b>0501510</b>	PVC milk tube   6 x 9 mm   crystal clear   100 mtr/coil
<b>0501511</b>	PVC milk tube   6 x 10 mm   crystal clear   100 mtr/coil
<b>0501514</b>	PVC milk tube   7 x 10 mm   crystal clear   100 mtr/coil



## PVC Milk tube transparent reinforced

<b>1307230</b>	PVC milk tube   25 x 34 mm   transparent reinforced   50 mtr/coil
<b>1307204</b>	PVC milk tube   28 x 36 mm   transparent reinforced   25 mtr/coil



## PVC Micky Mouse milk tube

<b>1314099</b>	PVC Micky Mouse milk tube   7 x 14 x 2 + 14 x 23 mm   15 mtr/coil
<b>1311482</b>	PVC Micky Mouse milk tube   6,5 x 13 + 12,5 x 21 mm   50 mtr/coil





## Silicone milk tube transparent

<b>1310466</b>	Silicone milk tube	7 x 15 mm	transparent	20 mtr/coil
<b>1308230</b>	Silicone milk tube	9 x 17 mm	transparent	20 mtr/coil
<b>1308231</b>	Silicone milk tube	11 x 18 mm	transparent	20 mtr/coil
<b>1300340</b>	Silicone milk tube	13 x 27 mm	transparent	20 mtr/coil
<b>1300341</b>	Silicone milk tube	14,3 x 24 mm	transparent	20 mtr/coil
<b>1300342</b>	Silicone milk tube	15,9 x 28 mm	transparent	20 mtr/coil
<b>1308137</b>	Silicone milk tube	16 x 26 mm	transparent	20 mtr/coil
<b>1301967</b>	Silicone milk tube	19 x 29 mm	transparent	10 mtr/coil
<b>1310474</b>	Silicone milk tube	19 x 31,8 mm	transparent	10 mtr/coil
<b>1310476</b>	Silicone milk tube	28 x 38 mm	transparent	10 mtr/coil
<b>1310478</b>	Silicone milk tube	28 x 42 mm	transparent	10 mtr/coil
<b>1310480</b>	Silicone milk tube	38 x 52 mm	transparent	10 mtr/coil



## Silicone milk tube transparent blue

<b>1310464</b>	Silicone milk tube	7 x 13,5 mm	blue	20 mtr/coil   corr. Fullwood 30327
<b>1310461</b>	Silicone milk tube	12 x 21 mm	blue	20 mtr/coil   corr. Fullwood 30312
<b>1310463</b>	Silicone milk tube	15,5 x 27 mm	blue	20 mtr/coil   corr. Fullwood 30330
<b>1307207</b>	Silicone milk tube	15,9 x 28 mm	blue	20 mtr/coil



## Silicone milk tube massive blue

<b>1310452</b>	Silicone milk tube	9,1 x 18 mm	massive	blue	20 mtr/coil
<b>1310454</b>	Silicone milk tube	10 x 16 mm	massive	blue	20 mtr/coil
<b>1310458</b>	Silicone milk tube	13,5 x 28,5 mm	massive	blue	20 mtr/coil
<b>1307221</b>	Silicone milk tube	14,3 x 24 mm	massive	blue	20 mtr/coil
<b>1310460</b>	Silicone milk tube	15,5 x 27 mm	massive	blue	20 mtr/coil
<b>1310462</b>	Silicone milk tube	18 x 28 mm	massive	blue	20 mtr/coil



## Silicone milk tube massive green

<b>1310479</b>	Silicone milk tube	14 x 24 mm	massive	green	20 mtr/coil
<b>1307206</b>	Silicone milk tube	15,9 x 28 mm	massive	green	20 mtr/coil



## Silicone milk tube Hysil

<b>1308203</b>	Silicone milk tube   Hysil   14 x 25,2 mm   transparant   30 mtr/coil
<b>1308204</b>	Silicone milk tube   Hysil   15,5 x 27 mm   transparant   30 mtr/coil



## Silicone Micky Mouse milk tube

<b>1314475</b>	Silicone Micky Mouse milk tube   16 x 26 x 2 + 7,6 x 14 mm   15 mtr/coil
----------------	--



## Rubber milk tube green line

<b>1300319</b>	Rubber milk tube   12 x 23 mm   1 green line   25 mtr/coil
<b>1300323</b>	Rubber milk tube   14 x 25 mm   1 green line   25 mtr/coil
<b>1309759</b>	Rubber milk tube   16 x 27 mm   1 green line   25 mtr/coil
<b>1300328</b>	Rubber milk tube   19 x 33 mm   1 green line   25 mtr/coil



## Rubber milk tube orange line

<b>1311900</b>	Rubber milk tube   14 x 25 mm   1 orange line   25 mtr/coil
<b>1300325</b>	Rubber milk tube   16 x 27 mm   1 orange line   25 mtr/coil
<b>1300327</b>	Rubber milk tube   19 x 33 mm   1 orange line   25 mtr/coil
<b>1300329</b>	Rubber milk tube   23,5 x 38 mm   1 orange line   25 mtr/coil



## Rubber milk tube blue line

<b>1301928</b>	Rubber milk tube   14 x 25 mm   1 blue line   25 mtr/coil
<b>1301927</b>	Rubber milk tube   16 x 27 mm   1 blue line   25 mtr/coil



## Rubber milk tube white line

<b>1308365</b>	Rubber milk tube   6,4 x 13 mm   1 white line   50 mtr/coil
<b>1308360</b>	Rubber milk tube   8 x 16 mm   1 white line   25 mtr/coil
<b>1307201</b>	Rubber milk tube   9,5 x 16 mm   1 white line   50 mtr/coil
<b>1309990</b>	Rubber milk tube   10 x 19 mm   1 white line   25 mtr/coil
<b>1308361</b>	Rubber milk tube   13 x 23 mm   1 white line   20 mtr/coil
<b>1307182</b>	Rubber milk tube   14 x 25 mm   1 white line   20 mtr/coil
<b>1307184</b>	Rubber milk tube   15 x 26 mm   1 white line   25 mtr/coil
<b>1315160</b>	Rubber milk tube   16 x 27 mm   1 white line   25 mtr/coil



## Rubber milk tube black

<b>1309611</b>	Rubber milk tube   29 x 46 mm   black   15 mtr/coil
----------------	---



## Rubber Micky Mouse milk tube white line

<b>1309998</b>	Rubber micky mouse milk tube   7 x 14 x 2 + 14 x 25 mm   1 white line   20 mtr/coil
<b>1309999</b>	Rubber micky mouse milk tube   7 x 14 x 2 + 16 x 27 mm   1 white line   20 mtr/coil



## Milk tube short silicone corr. DeLaval

<b>1310366</b>	Milk tube   short   silicone   8 x 300 x 10 mm   corr. DeLaval 985.880
----------------	--



## Milk tube short rubber

<b>1307211</b>	Milk tube   short   rubber   8,5 x 150 x 8,5 mm   6 ridges at one side
<b>1308218</b>	Milk tube   short   rubber   10 x 140 x 10 mm   6 ridges at one side   corr. Westfalia 7021.7101.020
<b>1308219</b>	Milk tube   short   rubber   10 x 160 x 10 mm   6 ridges at one side   corr. Westfalia 7021.7101.030
<b>1309566</b>	Milk tube   short   rubber   10 x 180 x 10 mm   6 ridges at one side   corr. Westfalia 7021.7101.090



## Milk tube short rubber conical

<b>1309568</b>	Milk tube   short   rubber   10 x 140 x 8,5 mm   6 ridges at one side   conical   corr. Westfalia 7021.7101.000
<b>1300351</b>	Milk tube   short   rubber   10 x 180 x 8,5 mm   6 ridges at one side   conical   corr. Westfalia 7021.7101.010



## Milk tube short rubber two sides ridges

<b>1307212</b>	Milk tube   short   rubber   8,5 x 150 x 8,5 mm   6 ridges at 2 sides
<b>1307213</b>	Milk tube   short   rubber   8,5 x 180 x 8,5 mm   6 ridges at 2 sides



## Milk tube short rubber corr. Westfalia

<b>1300346</b>	Milk tube   short   rubber   12 x 130 x 12 mm   corr. Westfalia 7021.7101.040
<b>1307214</b>	Milk tube   short   rubber   12 x 160 x 12 mm   corr. Westfalia 7021.7101.050



## Milk tube short rubber one side reinforced

<b>1307209</b>	Milk tube   short   rubber   8,5 x 150 x 8,5 mm   reinforced at one side
<b>1307210</b>	Milk tube   short   rubber   8,5 x 180 x 8,5 mm   reinforced at one side



## Milk tube short rubber reinforced conical

<b>1307215</b>	Milk tube   short   rubber   10 x 150 x 8,5 mm   reinforced   conical
<b>1307216</b>	Milk tube   short   rubber   10 x 180 x 8,5 mm   reinforced   conical



## Milk tube short rubber corr. DeLaval

<b>1310365</b>	Milk tube   short   rubber   8 x 300 x 10 mm   corr. DeLaval 985.880
<b>1310367</b>	Milk tube   short   rubber   8 x 300 x 8 mm   corr. DeLaval 961.406-02



## Milk tube short rubber corr. Meltec

**1309865** Milk tube | short | rubber | 12 x 160 x 9,5 mm | reinforced | corr. Meltec



## PVC pulsation tube single blue line

**1301935** PVC pulsation tube | 7 x 14 mm | single | blue line | 25 mtr/coil



## PVC pulsation tube double blue

**1300422** PVC pulsation tube | 7 x 13 mm | double | blue | 30 mtr/coil



## PVC pulsation tube double blue line

**1300399** PVC pulsation tube | 7 x 13,4 mm | double | blue line | 25 mtr/coil



## Silicone pulsation tube double white

**1307222** Silicone pulsation tube | 7 x 14 mm | double | white | 20 mtr/coil

**1310468** Silicone pulsation tube | 8 x 15 mm | double | white | 20 mtr/coil

**1308232** Silicone pulsation tube | 11 x 19 mm | double | white | 20 mtr/coil



## Silicone pulsation tube double massive green

**1310473** Silicone pulsation tube | 7 x 13 mm | double | massive | green | 20 mtr/coil



## Silicone pulsation tube double blue

**1310465** Silicone pulsation tube | 7 x 14 mm | double | transparant | blue | 20 mtr/coil

**1310453** Silicone pulsation tube | 7,6 x 13,2 mm | double | platinum | blue | 20 mtr/coil



## Rubber pulsation tube double

<b>1300316</b>	Rubber pulsation tube   7,6 x 13,2 mm   double   orange line   25 mtr/coil
<b>1300317</b>	Rubber pulsation tube   7,6 x 13,2 mm   double   green line   25 mtr/coil
<b>1300318</b>	Rubber pulsation tube   7,6 x 13,2 mm   double   blue line   25 mtr/coil



## Rubber pulsation tube single orange line

<b>1308359</b>	Rubber pulsation tube   7 x 14 mm   single   orange line   50 mtr/coil
----------------	--



## Rubber pulsation tube single red line

<b>1315055</b>	Rubber pulsation tube   11 x 21 mm   single   red line   35 mtr/coil
<b>1315057</b>	Rubber pulsation tube   13 x 23 mm   single   red line   35 mtr/coil



## Rubber pulsation tube single blue line

<b>1310853</b>	Rubber pulsation tube   7 x 13 mm   single   blue line   50 mtr/coil
----------------	--



## Pulsation tube short rubber orange line

<b>1314080</b>	Pulsation tube   short   rubber   6,4 x 155 x 6,4 mm   orange line
<b>1314085</b>	Pulsation tube   short   rubber   7,4 x 200 x 7,4 mm   orange line



## Pulsation tube short rubber blue line

<b>1314070</b>	Pulsation tube   short   rubber   6,4 x 155 x 6,4 mm   blue line
<b>1314076</b>	Pulsation tube   short   rubber   7,4 x 180 x 7,4 mm   blue line
<b>1314075</b>	Pulsation tube   short   rubber   7,4 x 200 x 7,4 mm   blue line



## Pulsation tube short rubber green line

<b>1314090</b>	Pulsation tube   short   rubber   6,4 x 155 x 6,4 mm   green line
<b>1314095</b>	Pulsation tube   short   rubber   7,4 x 200 x 7,4 mm   green line



## Pulsation tube short rubber red line

<b>1307217</b>	Pulsation tube   short   rubber   7 x 180 x 7 mm   red line
<b>1307218</b>	Pulsation tube   short   rubber   7 x 205 x 7 mm   red line
<b>1300348</b>	Pulsation tube   short   rubber   7 x 230 x 7 mm   red line
<b>1310398</b>	Pulsation tube   short   rubber   7 x 270 x 7 mm   red line
<b>1307219</b>	Pulsation tube   short   rubber   7,3 x 205 x 7,3 mm   red line
<b>1307225</b>	Pulsation tube   short   rubber   7,3 x 230 x 7,3 mm   red line



## Pulsation tube short rubber white line

<b>1300344</b>	Pulsation tube   short   rubber   8 x 178 x 8 mm   white line
<b>1308141</b>	Pulsation tube   short   rubber   8 x 300 x 8 mm   white line



## Pulsation tube short rubber reinforced

<b>1300349</b>	Pulsation tube   short   rubber   6 x 230 x 6 mm   reinforced   green
<b>1309982</b>	Pulsation tube   short   rubber   7,5 x 230 x 7,5 mm   reinforced   blue
<b>1300350</b>	Pulsation tube   short   rubber   6 x 230 x 6 mm   reinforced   black
<b>1309767</b>	Pulsation tube   short   rubber   7,5 x 205 x 7,5 mm   reinforced   black
<b>1309768</b>	Pulsation tube   short   rubber   7,5 x 230 x 7,5 mm   reinforced   black
<b>1307224</b>	Pulsation tube   short   rubber   6 x 230 x 6 mm   reinforced   orange
<b>1309981</b>	Pulsation tube   short   rubber   7,5 x 230 x 7,5 mm   reinforced   orange



## Robot tube silicone corr. Westfalia

<b>1314335</b>	Robot tube   silicone   10 x 16 mm   corr. Westfalia   25 mtr/coil
<b>1314355</b>	Robot tube   silicone   10 x 18 mm   corr. Westfalia   25 mtr/coil
<b>1314345</b>	Robot tube   silicone   20 x 30 mm   corr. Westfalia   25 mtr/coil





## Robot tube Duplo silicone corr. Lely

<b>1314350</b>	Robot tube   rubber   12 x 22 mm + 6,5 x 15 mm   corr. Lely A3   20 mtr/coil
<b>1314360</b>	Robot tube   rubber   14 x 25 mm + 9 x 18 mm   corr. Lely A2   20 mtr/coil
<b>1314410</b>	Robot tube   silicone   14 x 25 mm + 9 x 18 mm   corr. Lely A2   60 cm length
<b>1314425</b>	Robot tube   silicone   14 x 25 mm + 9 x 18 mm   corr. Lely A2   70 cm length
<b>1314400</b>	Robot tube   silicone   12 x 22 mm + 6,5 x 15 mm   corr. Lely A3/A4   101 cm length
<b>1314480</b>	Robot tube   silicone   12 x 22 mm + 6,5 x 15 mm   corr. Lely A3/A4   114 cm length   two holes
<b>1314490</b>	Robot tube   silicone   12 x 22 mm + 6,5 x 15 mm   corr. Lely A3/A4   114 cm length
<b>1314450</b>	Robot tube   silicone   12 x 22 mm + 6,5 x 15 mm   corr. Lely A3/A4   119 cm length
<b>1314435</b>	Robot tube set   60 cm tubes   corr. Lely A2
<b>1314445</b>	Robot tube set   70 cm tubes   corr. Lely A2
<b>1314430</b>	Robot tube set   corr. Lely A3
<b>1314455</b>	Robot tube set   corr. Lely A4



## Robot tube silicone corr. DeLaval

<b>1314300</b>	Robot tube   rubber   11,5 x 20 x 3,5 mm   corr. DeLaval 917.013-01   25 mtr/coil
----------------	---



## Sleeve corr. Lely

<b>1311568</b>	Sleeve   silicone   red   corr. Lely
----------------	--------------------------------------



## Robot tube short corr. DeLaval

<b>1314440</b>	Robot tube   short   172/178 mm   corr. DeLaval 907.449-03
----------------	--





## Milk transportation tube

<b>1309667</b>	Milk transportation tube   32 x 45 mm   40 mtr/coil
<b>1309664</b>	Milk transportation tube   38 x 51 mm   40 mtr/coil
<b>1309642</b>	Milk transportation tube   40 x 52 mm   30 mtr/coil
<b>1309665</b>	Milk transportation tube   51 x 64 mm   40 mtr/coil
<i>Also available per meter</i>	



## Suction- and pressure tube

<b>0520425</b>	Armorvin suction and pressure tube   25 x 33 mm   vacuum 0,85 bar   work pressure 5 bar   60 mtr/coil
<b>0520430</b>	Armorvin suction and pressure tube   30 x 38,4 mm   vacuum 0,85 bar   work pressure 4,5 bar   60 mtr/coil
<b>0520440</b>	Armorvin suction and pressure tube   40 x 49,4 mm   vacuum 0,85 bar   work pressure 3 bar   30 mtr/coil
<b>0520450</b>	Armorvin suction and pressure tube   50 x 60 mm   vacuum 0,8 bar   work pressure 3 bar   30 mtr/coil
<b>0520460</b>	Armorvin suction and pressure tube   60 x 72 mm   vacuum 0,8 bar   work pressure 2,5 bar   30 mtr/coil



## Water tube PVC MasterPlus

<b>7024795</b>	PVC MasterPlus hose phthalate-free   12,5 mm   16 bar   50 mtr/coil   max 60°C
<b>7024796</b>	PVC MasterPlus hose phthalate-free   15 mm   13 bar   25 mtr/coil   max 60°C
<b>7024797</b>	PVC MasterPlus hose phthalate-free   19 mm   11 bar   25 mtr/coil   max 60°C
<b>7024798</b>	PVC MasterPlus hose phthalate-free   19 mm   11 bar   50 mtr/coil   max 60°C
<b>7024799</b>	PVC MasterPlus hose phthalate-free   25 mm   9 bar   25 mtr/coil   max 60°C



## Water tube Trix

<b>1340470</b>	Trix water tube   13 x 19 mm   20 bar   40 mtr/coil   - 40 up to 100°C
<b>1340472</b>	Trix water tube   19 x 27 mm   20 bar   40 mtr/coil   - 40 up to 100°C
<b>1340476</b>	Trix water tube   25 x 34 mm   20 bar   40 mtr/coil   - 40 up to 100°C
<b>1340478</b>	Trix water tube   32 x 43 mm   20 bar   40 mtr/coil   - 40 up to 100°C



## Water tube EPDM

<b>0502356</b>	EPDM water tube   type Jumbo   13 x 19 x 3 mm   15 bar   40 mtr/coil   - 40 up to 125°C
<b>0502357</b>	EPDM water tube   type Jumbo   19 x 27 x 4 mm   15 bar   40 mtr/coil   - 40 up to 125°C
<b>0502358</b>	EPDM water tube   type Jumbo   25 x 37 x 6 mm   15 bar   40 mtr/coil   - 40 up to 125°C



## Washing machine tube

<b>1301693</b>	Washing machine tube   1,5 meter   ¾" connection   max. 95°C   60 bar
<b>1301697</b>	Washing machine tube   2,5 meter   ¾" connection   max. 95°C   60 bar
<b>1301694</b>	Joint



## Y-tube

<b>1300352</b>	Y-tube   for pulsator connection
----------------	----------------------------------



## S/S shut off valve

<b>1301721</b>	Shut off valve   S/S   max. Ø 28 mm
<b>1307395</b>	Diaphragm   Ø 134 mm



## Diaphragm for shut off valve

<b>1301270</b>	Diaphragm   shut off valve   Ø 122 mm
----------------	---------------------------------------

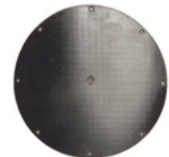

## Plastic shut off valve

<b>1307396</b>	Shut off valve   plastic   with bolt M8 x 100 mm
<b>1307398</b>	Shut off valve   plastic   without bolt
<b>1307397</b>	Diaphragm   white   Ø 139 mm



## S/S shut off valve small model

<b>1330080</b>	Shut off valve   S/S   small model   max. Ø 14 mm   fitt. milk-pump Strangko
<b>1330082</b>	Diaphragm



## Plastic shut off valve corr. DeLaval

<b>1310830</b>	Shut off valve   plastic   corr. DeLaval
<b>1310835</b>	Diaphragm   corr. DeLaval 955.938-02



## S/S pinch clamp

<b>1301264</b>	Pinch clamp   S/S   12 x 23 mm
<b>1301265</b>	Pinch clamp   S/S   16 x 27 mm



## Plastic pinch clamp

<b>1307093</b>	Pinch clamp   plastic   12 x 24 mm
<b>1307094</b>	Pinch clamp   plastic   16 x 28 mm



## S/S hose clamp

<b>1309862</b>	Hose clamp   S/S   8-16 mm
<b>1301687</b>	Hose clamp   S/S   12-22 mm
<b>1301688</b>	Hose clamp   S/S   16-27 mm
<b>1301689</b>	Hose clamp   S/S   25-40 mm
<b>1309864</b>	Hose clamp   S/S   40-60 mm
<b>1300500</b>	Hose clamp   S/S   32-50 mm
<b>1300501</b>	Hose clamp   S/S   50-70 mm
<b>1300502</b>	Hose clamp   S/S   60-80 mm
<b>1300503</b>	Hose clamp   S/S   80-100 mm
<b>1300530</b>	Hose clamp   S/S   90-110 mm
<b>1300531</b>	Hose clamp   S/S   100-120 mm
<b>1300504</b>	Hose clamp   S/S   32-50 mm   cut version
<b>1300505</b>	Hose clamp   S/S   50-70 mm   cut version
<b>1300506</b>	Hose clamp   S/S   60-80 mm   cut version
<b>1300507</b>	Hose clamp   S/S   80-100 mm   cut version



## Tube bundle ring rubber black

1310427 Tube bundle ring | rubber | 28 x 6,6 mm | black

1310408 Tube bundle ring | rubber | 35 x 6,6 mm | black



## Tube bundle ring rubber blue

1310430 Tube bundle ring | rubber | 28 x 6 mm | blue



## Tube bundle ring silicone

1310404 Tube bundle ring | silicone | 31 mm | blue

1310677 Tube bundle ring | silicone | 32 mm | white



## Tube holder clip plastic

1308243 Tube holder clip | plastic | for 3 tubes | blue

1301674 Tube holder clip | plastic | for 3 tubes | black



## Tube holder clip single plastic

1306971 Tube holder clip | plastic | single | blue | corr. DeLaval

1306970 Tube holder clip | plastic | single | orange



## Tube holder clip plastic corr. Fullwood

1301673 Tube holder clip | plastic | black | corr. Fullwood



## Tube scissor

1300354 Tube scissor | heavy model | orange handle

1307232 Blade



## S/S spring

<b>1300330</b>	S/S spring   tube reinforcing   Ø 22 mm
<b>1300331</b>	S/S spring   tube reinforcing   Ø 28 mm



## Brush

<b>1309585</b>	Brush   for milk tube   Ø 10 mm x 400 mm
<b>1309589</b>	Brush   for milk tube   Ø 15 mm x 1000 mm
<b>1309590</b>	Brush   for milk tube   Ø 15 mm x 1500 mm
<b>1309591</b>	Brush   for milk tube   Ø 15 mm x 2000 mm



## Swing arm

<b>1307236</b>	Swing arm   plastic   1¼"   20" aluminium hook
<b>1310548</b>	Swing arm   plastic   1¼"   24" aluminium hook
<b>1307237</b>	Aluminium hook   20"
<b>1307238</b>	Aluminium hook   24"
<b>1307239</b>	Swing arm   plastic   1¼"   without hook



## Hose connector

<b>1307354</b>	Hose connector   plastic   ¾" x ½"   white
----------------	--



## Pull discharger

<b>1301720</b>	Pull discharger   S/S   max. Ø 16 mm inside diameter
----------------	--



## S/S tube connector

<b>1311290</b>	Tube connector   S/S   Ø 16 x 1 x 100 mm
<b>1311292</b>	Tube connector   S/S   Ø 18 x 1 x 100 mm
<b>1311294</b>	Tube connector   S/S   Ø 22 x 1 x 50 mm
<b>1311296</b>	Tube connector   S/S   Ø 22 x 1 x 100 mm



## Y-piece

<b>1307359</b>	Y-piece   plastic   3 x 6 mm
<b>1307353</b>	Y-piece   plastic   5 x 8 mm
<b>1301916</b>	Y-piece   plastic   6 x 10 mm   for sheep/goat milking clusters
<b>1307357</b>	Y-piece   plastic   8 x 12 mm
<b>1307360</b>	Y-piece   plastic   10 x 14 mm
<b>1301915</b>	Y-piece   plastic   12 x 14 mm   for sheep/goat milking clusters
<b>1301233</b>	Y-piece   plastic   12 x 16 mm
<b>1307364</b>	Y-piece   plastic   16 x 19 mm



## T-piece

<b>1301231</b>	T-piece   plastic   3 x 6 mm
<b>1301232</b>	T-piece   plastic   5 x 8 mm
<b>1301236</b>	T-piece   plastic   6 x 10 mm
<b>1301234</b>	T-piece   plastic   8 x 12 mm
<b>1301227</b>	T-piece   plastic   10 x 14 mm
<b>1301230</b>	T-piece   plastic   12 x 16 mm



## L-piece

<b>1301570</b>	L-piece   90°   plastic   3 x 6 mm
<b>1301571</b>	L-piece   90°   plastic   5 x 8 mm
<b>1301572</b>	L-piece   90°   plastic   6 x 10 mm
<b>1301573</b>	L-piece   90°   plastic   8 x 12 mm
<b>1301574</b>	L-piece   90°   plastic   10 x 14 mm
<b>1301575</b>	L-piece   90°   plastic   12 x 16 mm

## S/S Y-piece

<b>1330038</b>	Y-piece   S/S   12 x 1,5 mm   length 100 mm
<b>1330039</b>	Y-piece   S/S   18 x 1,5 mm   length 170 mm





Chapter 3

# MILK- AND VACUUM LINE PARTS

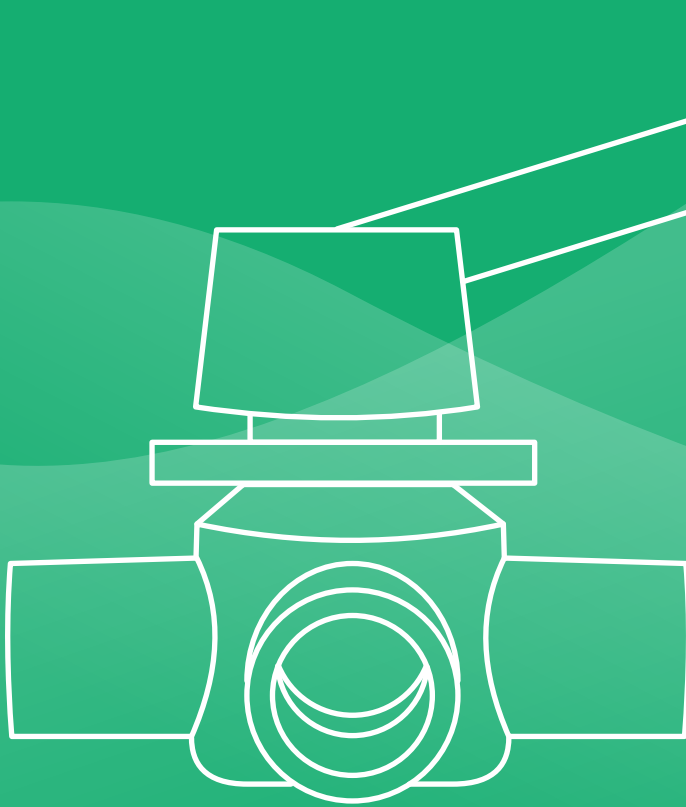



## Chapter 3 Milk- and vacuum line parts

S/S milk entries straight	P51
S/S milk entries 90°	P51
S/S milk entries 90° parallel	P52
S/S milk entries 180°	P52
Gaskets for milk entries with pipe clamp	P52
S/S milk entries straight	P53
S/S milk entries 90° angled	P53
S/S milk entries 90° parallel	P54
S/S milk entries 90° 45° left	P54
S/S milk entries 180°	P54
Gaskets 35 x 33 mm	P55
S/S milk entries with thread	P55
S/S hose clamp	P55
Milk entry plastic	P55
Slide valve	P56
S/S sliding tap	P56
Accessoires for slide valve	P56
Combi valve corr. DeLaval	P56
Combi valve	P56
Gaskets	P57
Socket silicone	P57
Tee silicone	P57
Elbow silicone	P57
Bend silicone	P57
Socket rubber	P58
Reduction socket rubber conical	P58
Reduction socket rubber	P58
Reduction socket rubber long model	P58
Reduction socket rubber corr. DeLaval	P58
Reduction socket rubber corr. Miele	P59
Tee rubber	P59
Reduction Tee rubber	P59
Reduction Tee rubber corr. Westfalia	P59
Elbow rubber	P59
Reduction elbow rubber	P60
Reduction elbow rubber corr. Miele	P60
Bend long rubber	P60
Reduction elbow long rubber	P60

Bend S/S 45° DN	P60
Bend S/S 45° inch	P60
Bend short S/S 90° inch	P61
Bend short S/S 90° DN	P61
Bend S/S 90°	P61
Bend S/S 90° long	P61
Bend short S/S 90° 3D	P62
U-bend S/S	P62
Reduction socket S/S	P62
Tee S/S inch	P63
Tee S/S DN	P63
Cross piece S/S	P63
Inlet bend	P63
S/S tube connector	P63
S/S bend 90°	P63
Clamp bend 45°	P64
Clamp bend 90°	P64
Clamp coupling	P64
S/S clamps (ferrules)	P64
Gasket	P65
Gasket silicone	P65
Triclover V-clamp light	P65
Triclover V-clamp heavy	P65
S/S milk line coupling	P66
Socket white	P66
S/S milk line coupling blue	P66
Socket blue	P66
Nylon coupling	P67
Socket	P67
Expanding coupling inch SMS	P67
Gasket for expanding coupling inch SMS	P67
Expanding coupling inch S/S	P67
Expanding coupling DN	P68
Gasket	P68
Tool	P68
Tube expander inch	P68
Tube expander DN S/S	P69
Cutting device inch	P69
Cutting device DN	P69
Combined clamp- and cutting device DN	P69

Endcap rubber	P70
Endcap rubber with S/S sprayplate	P70
Endcap rubber with S/S tube	P70
Plug	P70
Sealing cap	P70
Butterfly valve S/S	P71
Butterfly valve   S/S with handle	P71
Socket for butterfly valve	P71
Butterfly valve rubber	P71
Two-way valve white	P71
Two-way valve green/blue	P72
Two- and Three way valve	P72
Bolt saddles	P72
Vacuum valve	P73
Vacuum valve white imperial	P73
Pipe clamp Easy Click	P73
Pipe clamp	P74
Pipe clamp with ½" threat	P74
Accessories for pipe clamps	P74
Mini ball valve	P74
Ball valve	P75
Ball valve brass with steel lever	P75
Ball valve brass with S/S/ lever	P75
Drain valve plastic	P75
Drain valve plastic corr. DeLaval	P76
Drain valve nickel plated	P76
Drain valve rubber corr. DeLaval	P76
Drain valve rubber corr. Gascoigne Melotte	P76
Drain valve corr. Westfalia	P76
Socket PVC	P76
Reduction socket PVC	P77
Reduction socket PVC	P77
Tee PVC	P77
Elbow 45° PVC	P77
Elbow 90°   PVC	P78
Bend PVC	P78
Cap PVC	P78
PVC insulation tape	P79
Seal tape	P79
Thread sealant	P79

Glue	P79
Cleaner	P79
Non return valve horizontal brass	P80
Non return valve brass	P80
Brass ball float valve	P80
Float	P80
Vacuum valve right-angled	P80
Vacuum valve straight	P81
Vacuum clamp valve right-angled 90°	P81
Vacuum clamp valve	P81
Vacuum valve	P81
Vacuum valve connecting tube	P81
Gasket for vacuum valves	P81

## S/S milk entries straight

<b>1300512</b>	Milk entry   S/S   straight   1½"   14-16 mm
<b>1300513</b>	Milk entry   S/S   straight   2"   14-16 mm
<b>1300514</b>	Milk entry   S/S   straight   2½"   14-16 mm
<b>1300515</b>	Milk entry   S/S   straight   3"   14-16 mm
<b>1300516</b>	Milk entry   S/S   straight   1½"   16-18 mm
<b>1300517</b>	Milk entry   S/S   straight   2"   16-18 mm
<b>1300518</b>	Milk entry   S/S   straight   2½"   16-18 mm
<b>1300519</b>	Milk entry   S/S   straight   3"   16-18 mm
<b>1300520</b>	Milk entry   S/S   straight   1½"   20-22 mm
<b>1300521</b>	Milk entry   S/S   straight   2½"   20-22 mm
<b>1300522</b>	Milk entry   S/S   straight   2"   20-22 mm
<b>1300523</b>	Milk entry   S/S   straight   3"   20-22 mm
<b>1300554</b>	Milk entry   S/S   straight   1½"   24-26 mm
<b>1300555</b>	Milk entry   S/S   straight   2"   24-26 mm
<b>1300556</b>	Milk entry   S/S   straight   2½"   24-26 mm
<b>1300557</b>	Milk entry   S/S   straight   3"   24-26 mm



## S/S milk entries 90°

<b>1300524</b>	Milk entry   S/S   90°   1½"   14-16 mm
<b>1300525</b>	Milk entry   S/S   90°   2"   14-16 mm
<b>1300526</b>	Milk entry   S/S   90°   2½"   14-16 mm
<b>1300539</b>	Milk entry   S/S   90°   3"   14-16 mm
<b>1300528</b>	Milk entry   S/S   90°   1½"   16-18 mm
<b>1300529</b>	Milk entry   S/S   90°   2"   16-18 mm
<b>1300534</b>	Milk entry   S/S   90°   2½"   16-18 mm
<b>1300538</b>	Milk entry   S/S   90°   3"   16-18 mm
<b>1300532</b>	Milk entry   S/S   90°   1½"   20-22 mm
<b>1300533</b>	Milk entry   S/S   90°   2"   20-22 mm
<b>1300534</b>	Milk entry   S/S   90°   2½"   20-22 mm
<b>1300539</b>	Milk entry   S/S   90°   3"   20-22 mm



## S/S milk entries 90° parallel

<b>1300585</b>	Milk entry   S/S   90°   1½"   14-16 mm
<b>1300586</b>	Milk entry   S/S   90°   2"   14-16 mm
<b>1300587</b>	Milk entry   S/S   90°   2½"   14-16 mm
<b>1300588</b>	Milk entry   S/S   90°   3"   14-16 mm
<b>1300589</b>	Milk entry   S/S   90°   1½"   16-18 mm
<b>1300590</b>	Milk entry   S/S   90°   2"   16-18 mm
<b>1300591</b>	Milk entry   S/S   90°   2½"   16-18 mm
<b>1300592</b>	Milk entry   S/S   90°   3"   16-18 mm
<b>1300594</b>	Milk entry   S/S   90°   2"   20-22 mm
<b>1300595</b>	Milk entry   S/S   90°   2½"   20-22 mm
<b>1300596</b>	Milk entry   S/S   90°   3"   20-22 mm



## S/S milk entries 180°

<b>1300536</b>	Milk entry   S/S   180°   1½"   14-16 mm
<b>1300537</b>	Milk entry   S/S   180°   2"   14-16 mm
<b>1300542</b>	Milk entry   S/S   180°   2½"   14-16 mm
<b>1300543</b>	Milk entry   S/S   180°   3"   14-16 mm
<b>1300540</b>	Milk entry   S/S   180°   1½"   16-18 mm
<b>1300541</b>	Milk entry   S/S   180°   2"   16-18 mm
<b>1300546</b>	Milk entry   S/S   180°   2½"   16-18 mm
<b>1300547</b>	Milk entry   S/S   180°   3"   16-18 mm
<b>1300548</b>	Milk entry   S/S   180°   1½"   20-22 mm
<b>1300549</b>	Milk entry   S/S   180°   2"   20-22 mm
<b>1300550</b>	Milk entry   S/S   180°   2½"   20-22 mm
<b>1300551</b>	Milk entry   S/S   180°   3"   20-22mm



## Gaskets for milk entries with pipe clamp

<b>1300564</b>	Gasket   for milk entry with pipe clamp   Ø 16 mm
<b>1300565</b>	Gasket   for milk entry with pipe clamp   Ø 18 mm
<b>1300566</b>	Gasket   for milk entry with pipe clamp   Ø 22 mm



## S/S milk entries straight

<b>1300435</b>	Milk entry   S/S   hose clamp   straight   1½"   Ø 14-16 mm
<b>1300436</b>	Milk entry   S/S   hose clamp   straight   2"   Ø 14-16 mm
<b>1300437</b>	Milk entry   S/S   hose clamp   straight   2½"-3"   Ø 14-16 mm
<b>1300438</b>	Milk entry   S/S   hose clamp   straight   1½"   Ø 16-18 mm
<b>1300439</b>	Milk entry   S/S   hose clamp   straight   2"   Ø 16-18 mm
<b>1300440</b>	Milk entry   S/S   hose clamp   straight   2½"-3"   Ø 16-18 mm
<b>1310666</b>	Milk entry   S/S   hose clamp   straight   3½"-4"   Ø 16-18 mm
<b>1300441</b>	Milk entry   S/S   hose clamp   straight   1½"   Ø 20-22 mm
<b>1300442</b>	Milk entry   S/S   hose clamp   straight   2"   Ø 20-22 mm
<b>1300443</b>	Milk entry   S/S   hose clamp   straight   2½"-3"   Ø 20-22 mm
<b>1310664</b>	Milk entry   S/S   hose clamp   straight   3½"-4"   Ø 20-22 mm
<b>1300444</b>	Milk entry   S/S   hose clamp   straight   2"   Ø 24-26 mm
<b>1300445</b>	Milk entry   S/S   hose clamp   straight   2½"-3"   Ø 24-26 mm



## S/S milk entries 90° angled

<b>1300446</b>	Milk entry   S/S   hose clamp   90°   angled   1½"   Ø 14-16 mm
<b>1300447</b>	Milk entry   S/S   hose clamp   90°   angled   2"   Ø 14-16 mm
<b>1300448</b>	Milk entry   S/S   hose clamp   90°   angled   2½"-3"   Ø 14-16 mm
<b>1300449</b>	Milk entry   S/S   hose clamp   90°   angled   1½"   Ø 16-18 mm
<b>1300450</b>	Milk entry   S/S   hose clamp   90°   angled   2"   Ø 16-18 mm
<b>1300451</b>	Milk entry   S/S   hose clamp   90°   angled   2½"-3"   Ø 16-18 mm



## S/S milk entries 90° parallel

<b>1300484</b>	Milk entry   S/S   hose clamp   90°   parallel   1½"   Ø 14-16 mm
<b>1300485</b>	Milk entry   S/S   hose clamp   90°   parallel   2"   Ø 14-16 mm
<b>1300486</b>	Milk entry   S/S   hose clamp   90°   parallel   2½"-3"   Ø 14-16 mm
<b>1300487</b>	Milk entry   S/S   hose clamp   90°   parallel   1½"   Ø 16-18 mm
<b>1300488</b>	Milk entry   S/S   hose clamp   90°   parallel   2"   Ø 16-18 mm
<b>1300489</b>	Milk entry   S/S   hose clamp   90°   parallel   2½"-3"   Ø 16-18 mm
<b>1300490</b>	Milk entry   S/S   hose clamp   90°   parallel   1½"   Ø 20-22 mm
<b>1300491</b>	Milk entry   S/S   hose clamp   90°   parallel   2"   Ø 20-22 mm
<b>1300492</b>	Milk entry   S/S   hose clamp   90°   parallel   2½"-3"   Ø 20-22 mm



## S/S milk entries 90° 45° left

<b>1300457</b>	Milk entry   S/S   hose clamp   90°   45° left   1½"   Ø 14-16 mm
<b>1300458</b>	Milk entry   S/S   hose clamp   90°   45° left   2"   Ø 14-16 mm
<b>1300459</b>	Milk entry   S/S   hose clamp   90°   45° left   2½"-3"   Ø 14-16 mm
<b>1300460</b>	Milk entry   S/S   hose clamp   90°   45° left   1½"   Ø 16-18 mm
<b>1300461</b>	Milk entry   S/S   hose clamp   90°   45° left   2"   Ø 16-18 mm
<b>1300462</b>	Milk entry   S/S   hose clamp   90°   45° left   2½"-3"   Ø 16-18 mm



## S/S milk entries 180°

<b>1300475</b>	Milk entry   S/S   hose clamp   180°   1½"   Ø 14-16 mm
<b>1300476</b>	Milk entry   S/S   hose clamp   180°   2"   Ø 14-16 mm
<b>1300477</b>	Milk entry   S/S   hose clamp   180°   2½"-3"   Ø 14-16 mm
<b>1300478</b>	Milk entry   S/S   hose clamp   180°   1½"   Ø 16-18 mm
<b>1300479</b>	Milk entry   S/S   hose clamp   180°   2"   Ø 16-18 mm
<b>1300480</b>	Milk entry   S/S   hose clamp   180°   2½"-3"   Ø 16-18 mm





## Gaskets 35 x 33 mm

<b>1300509</b>	Gasket   35 x 33 mm   Ø 16 mm
<b>1300510</b>	Gasket   35 x 33 mm   Ø 18 mm
<b>1300511</b>	Gasket   35 x 33 mm   Ø 22 mm
<b>1311060</b>	Gasket   35 x 33 mm   Ø 24,5 mm



## S/S milk entries with thread

<b>1300600</b>	Milk entry   S/S   3/8" thread   Hose clamp Ø 32-51 mm
<b>1300602</b>	Milk entry   S/S   3/8" thread   Hose clamp Ø 60-80 mm
<b>1300604</b>	Milk entry   S/S   3/8" thread   Hose clamp Ø 80-100 mm
<b>1300601</b>	Milk entry   S/S   1" thread   Hose clamp Ø 32-51 mm
<b>1300603</b>	Milk entry   S/S   1" thread   Hose clamp Ø 60-80 mm
<b>1300605</b>	Milk entry   S/S   1" thread   Hose clamp Ø 80-100 mm
<b>1307112</b>	Gasket   55 x 55 mm   Ø 35 mm



## S/S hose clamp

<b>1309862</b>	Hose clamp   S/S   8-16 mm
<b>1301687</b>	Hose clamp   S/S   12-22 mm
<b>1301688</b>	Hose clamp   S/S   16-27 mm
<b>1301689</b>	Hose clamp   S/S   25-40 mm
<b>1309864</b>	Hose clamp   S/S   40-60 mm
<b>1300500</b>	Hose clamp   S/S   32-50 mm
<b>1300501</b>	Hose clamp   S/S   50-70 mm
<b>1300502</b>	Hose clamp   S/S   60-80 mm
<b>1300503</b>	Hose clamp   S/S   80-100 mm
<b>1300530</b>	Hose clamp   S/S   90-110 mm
<b>1300531</b>	Hose clamp   S/S   100-120 mm
<b>1300504</b>	Hose clamp   S/S   32-50 mm   cut version
<b>1300505</b>	Hose clamp   S/S   50-70 mm   cut version
<b>1300506</b>	Hose clamp   S/S   60-80 mm   cut version
<b>1300507</b>	Hose clamp   S/S   80-100 mm   cut version



## Milk entry plastic

<b>1300432</b>	Milk entry   plastic   Ø 40 mm   pipe Ø 16 mm
<b>1300428</b>	Milk entry   plastic   Ø 50 mm   pipe Ø 16 mm



## Slide valve

<b>1300424</b>	Slide valve   plastic   Ø 1½" - 14 mm   including gasket
<b>1300425</b>	Slide valve   plastic   Ø 2" - 14 mm   including gasket
<b>1300426</b>	Slide valve   plastic   Ø 1½" - 16 mm   including gasket
<b>1300427</b>	Slide valve   plastic   Ø 2" - 16 mm   including gasket



## S/S sliding tap

<b>1300495</b>	Sliding tap   S/S   Ø 14 x 16 mm   for milk entries
<b>1300496</b>	Sliding tap   S/S   Ø 16 x 18 mm   for milk entries
<b>1307100</b>	Sliding tap   S/S   180° turned   Ø 14 x 16 mm   for milk entries
<b>1300497</b>	Sliding tap   S/S   180° turned   Ø 16 x 18 mm   for milk entries



## Accessoires for slide valve

<b>1300498</b>	Sliding plate   S/S
<b>1300493</b>	Upper gasket   for blue milk entry
<b>1300494</b>	Lower gasket   for blue milk entry



## Combi valve corr. DeLaval

<b>1311080</b>	Combi valve   40 mm   corr. DeLaval MCP 100 997.590-82
<b>1311090</b>	Combi valve   51 mm   corr. DeLaval MCP 100 997.590-82
<b>1311092</b>	Sliding tap   corr. DeLaval MCP 100 997.520-01
<b>1308213</b>	Joint   for combi valve 40 mm   corr. DeLaval 965.423-01
<b>1308214</b>	Joint   for combi valve 52 mm   corr. DeLaval 965.423-01
<b>1309771</b>	Rubber ring   corr. DeLaval 968.501-01



## Combi valve

<b>1330060</b>	Combi valve   complete   Ø 52 mm   for 40 mm vacuum tube
<b>1330070</b>	Combi valve   complete   Ø 52 mm   for 50 mm vacuum tube
<b>1330068</b>	Combi valve   Ø 52 mm
<b>1330065</b>	Sliding tap   S/S   for combi valve Ø 16 mm and Ø 18 mm



## Gaskets

<b>1300415</b>	Upper gasket   Ø 14-16 mm   for S/S milk entries
<b>1300416</b>	Upper gasket   Ø 16-18 mm   for S/S milk entries
<b>1300244</b>	Gasket   rubber   26 x 23 mm   for Ø 16 mm
<b>1300423</b>	Gasket   rubber   30 x 30 mm   for Ø 18 mm



## Socket silicone

<b>1307063</b>	Socket   silicone   Ø 32 mm
<b>1307064</b>	Socket   silicone   Ø 40 mm
<b>1307065</b>	Socket   silicone   Ø 50 mm



## Tee silicone

<b>1307069</b>	Tee   silicone   Ø 32 mm
<b>1307070</b>	Tee   silicone   Ø 40 mm
<b>1307071</b>	Tee   silicone   Ø 50 mm



## Elbow silicone

<b>1307066</b>	Elbow   silicone   Ø 32 mm   90°
<b>1307067</b>	Elbow   silicone   Ø 40 mm   90°
<b>1307068</b>	Elbow   silicone   Ø 50 mm   90°



## Bend silicone

<b>1309730</b>	Bend   silicone   Ø 32 mm
----------------	---------------------------



## Socket rubber

<b>1301271</b>	Socket   rubber   Ø 30 mm
<b>1301272</b>	Socket   rubber   Ø 38 mm
<b>1301273</b>	Socket   rubber   Ø 40 mm
<b>1301274</b>	Socket   rubber   Ø 50 mm
<b>1301275</b>	Socket   rubber   Ø 63,5 mm
<b>1301276</b>	Socket   rubber   Ø 76,2 mm
<b>1309822</b>	Socket   rubber   Ø 90 mm
<b>1309823</b>	Socket   rubber   Ø 110 mm
<b>1310650</b>	Socket   rubber   Ø 125 mm



## Reduction socket rubber conical

<b>1300357</b>	Reduction socket   rubber   Ø 40 x 30 mm
<b>1300358</b>	Reduction socket   rubber   Ø 50 x 40 mm   short model 83 mm
<b>1300359</b>	Reduction socket   rubber   Ø 63,5 x 50 mm
<b>1310990</b>	Reduction socket   rubber   Ø 76 x 63 mm
<b>1310991</b>	Reduction socket   rubber   Ø 90 x 76 mm



## Reduction socket rubber

<b>1309826</b>	Reduction socket   rubber   Ø 37 x 23,5 mm
<b>1309827</b>	Reduction socket   rubber   Ø 37 x 30,5 mm
<b>1309829</b>	Reduction socket   rubber   Ø 45 x 37 mm
<b>1310621</b>	Reduction socket   rubber   Ø 48 x 30 mm



## Reduction socket rubber long model

<b>1316478</b>	Reduction socket   rubber   Ø 50 x 40 mm   long model 145 mm
----------------	--



## Reduction socket rubber corr. DeLaval

<b>1316475</b>	Reduction socket   rubber   Ø 38 x 32 mm   corr. DeLaval 950.723-01
----------------	---



## Reduction socket rubber corr. Miele

**1330084** Reduction socket | rubber | Ø 50 x 40 mm | corr. Miele 1854480



## Tee rubber

**1300368** Tee | rubber | Ø 30 mm

**1300369** Tee | rubber | Ø 38 mm

**1300370** Tee | rubber | Ø 40 mm

**1300371** Tee | rubber | Ø 50 mm

**1300372** Tee | rubber | Ø 63,5 mm

**1309813** Tee | rubber | Ø 76 mm



## Reduction Tee rubber

**1310636** Tee with reduction | rubber | Ø 50-50-38 mm | 90°



## Reduction Tee rubber corr. Westfalia

**1310388** Tee with reduction | rubber | Ø 49-28-14 mm | 90° | corr. Westfalia 0018-1434-700

**1310389** Tee with reduction | rubber | Ø 49-38-14 mm | 90° | corr. Westfalia 0018-1437-700



## Elbow rubber

**1300360** Elbow | rubber | Ø 25 mm | 90°

**1300361** Elbow | rubber | Ø 30 mm | 90°

**1301698** Elbow | rubber | Ø 38 mm | 90°

**1300362** Elbow | rubber | Ø 40 mm | 90°

**1300363** Elbow | rubber | Ø 50 mm | 90°

**1300364** Elbow | rubber | Ø 63 mm | 90°

**1300365** Elbow | rubber | Ø 76,2 mm | 90°



## Reduction elbow rubber

<b>1300366</b>	Reduction elbow   rubber   Ø 40-30 mm   90°
<b>1300367</b>	Reduction elbow   rubber   Ø 50-40 mm   90°
<b>1310511</b>	Reduction elbow   rubber   Ø 63-50 mm   90°
<b>1310512</b>	Reduction elbow   rubber   Ø 76-63 mm   90°



## Reduction elbow rubber corr. Miele

<b>1308346</b>	Reduction elbow   rubber   Ø 40-30 mm   corr. Miele
----------------	---



## Bend long rubber

<b>1309800</b>	Bend   long   rubber   Ø 30 mm   90°
<b>1309801</b>	Bend   long   rubber   Ø 40 mm   90°



## Reduction elbow long rubber

<b>1310892</b>	Reduction elbow   long   rubber   Ø 32 x 38 mm   90°
----------------	--



## Bend S/S 45° DN

<b>1311915</b>	Bend   S/S   45°   DN25   Ø 28 mm
<b>1311920</b>	Bend   S/S   45°   DN32   Ø 34 mm
<b>1311925</b>	Bend   S/S   45°   DN40   Ø 40 mm
<b>1311930</b>	Bend   S/S   45°   DN50   Ø 52 mm
<b>1311935</b>	Bend   S/S   45°   DN65   Ø 70 mm



## Bend S/S 45° inch

<b>1311704</b>	Bend   S/S   45°   1"   Ø 25,4 mm   short
<b>1311707</b>	Bend   S/S   45°   1¼"   Ø 31,8 mm   short
<b>1311708</b>	Bend   S/S   45°   1½"   Ø 38,1 mm   short
<b>1311709</b>	Bend   S/S   45°   2"   Ø 50,8 mm   short
<b>1311714</b>	Bend   S/S   45°   2½"   Ø 63,5 mm   short
<b>1311734</b>	Bend   S/S   45°   3"   Ø 76,1 mm   short



## Bend short S/S 90° inch

1311238	Bend	S/S	90°	1"	Ø 25,4 mm	short
1311203	Bend	S/S	90°	1¼"	Ø 31,8 mm	short
1311204	Bend	S/S	90°	1½"	Ø 38,1 mm	short
1311206	Bend	S/S	90°	2"	Ø 50,8 mm	short
1311207	Bend	S/S	90°	2½"	Ø 63,5 mm	short
1311209	Bend	S/S	90°	3"	Ø 76,1 mm	short



## Bend short S/S 90° DN

1311701	Bend	S/S	90°	DN25	Ø 28 mm	short
1311702	Bend	S/S	90°	DN32	Ø 34 mm	short
1311703	Bend	S/S	90°	DN40	Ø 40 mm	short
1311705	Bend	S/S	90°	DN50	Ø 52 mm	short
1311706	Bend	S/S	90°	DN65	Ø 70 mm	short



## Bend S/S 90°

1300400	Bend	S/S	90°	Ø 40 mm	182 x 182 mm	R 80 mm
1300401	Bend	S/S	90°	Ø 50,8 mm	223 x 223 mm	R 102 mm
1300402	Bend	S/S	90°	Ø 63,5 mm	265 x 265 mm	R 132 mm
1300403	Bend	S/S	90°	Ø 76,2 mm	295 x 295 mm	R 152 mm



## Bend S/S 90° long

1311249	Bend	S/S	90°	Ø 31,75 mm	1250 x 750 mm	R 100 mm
1300404	Bend	S/S	90°	Ø 40 mm	1250 x 750 mm	R 180 mm
1300405	Bend	S/S	90°	Ø 50,8 mm	1250 x 750 mm	R 102 mm
1300406	Bend	S/S	90°	Ø 63,5 mm	1250 x 750 mm	R 132 mm
1300407	Bend	S/S	90°	Ø 76,2 mm	1250 x 750 mm	R 152 mm
1300408	Bend	S/S	90°	Ø 101,6 mm	1250 x 750 mm	R305 mm



## Bend short S/S 90° 3D

<b>1311711</b>	Bend   S/S   3D   90°   Ø 25 mm   R 75 mm   short
<b>1311713</b>	Bend   S/S   3D   90°   Ø 32 mm   R 93 mm   short
<b>1311715</b>	Bend   S/S   3D   90°   Ø 38,1 mm   R 115 mm   short
<b>1311717</b>	Bend   S/S   3D   90°   Ø 40 mm   R 120 mm   short
<b>1311719</b>	Bend   S/S   3D   90°   Ø 50,8 mm   R 150 mm   short
<b>1311722</b>	Bend   S/S   3D   90°   Ø 52 mm   R 156 mm   short
<b>1311721</b>	Bend   S/S   3D   90°   Ø 63,5 mm   R 185 mm   short
<b>1311723</b>	Bend   S/S   3D   90°   Ø 70 mm   R 210 mm   short
<b>1311724</b>	Bend   S/S   3D   90°   Ø 76 mm   R 215 mm   short



## U-bend S/S

<b>1311237</b>	U-bend   S/S   180°   Ø 31,75 mm   R 64 mm
<b>1311241</b>	U-bend   S/S   180°   Ø 40 mm   R 80 mm
<b>1311244</b>	U-bend   S/S   180°   Ø 50,8 mm   R 102 mm
<b>1311246</b>	U-bend   S/S   180°   Ø 63,5 mm   R 132 mm
<b>1311247</b>	U-bend   S/S   180°   Ø 76,2 mm   R 152 mm



## Reduction socket S/S

<b>1311353</b>	Reduction socket   S/S   Ø 32 x 25 mm   1¼" x 1"
<b>1311355</b>	Reduction socket   S/S   Ø 38 x 32 mm   1½" x 1¼"
<b>1311357</b>	Reduction socket   S/S   Ø 40 x 32 mm   40 mm x 1¼"
<b>1307809</b>	Reduction socket   S/S   Ø 50 x 40 mm
<b>1311359</b>	Reduction socket   S/S   Ø 50,8 x 32 mm   2" x 1¼"
<b>1311361</b>	Reduction socket   S/S   Ø 50,8 x 38 mm   2" x 1½"
<b>1311363</b>	Reduction socket   S/S   Ø 50,8 x 40 mm   2" x 40 mm
<b>1311365</b>	Reduction socket   S/S   Ø 76 x 38 mm   3" x 1½"
<b>1311367</b>	Reduction socket   S/S   Ø 76 x 50 mm   3" x 2"
<b>1311369</b>	Reduction socket   S/S   Ø 76 x 63 mm   3" x 2½"





## Tee S/S inch

1330052	Tee   S/S   1"   Ø 25,4 mm
1330054	Tee   S/S   1¼"   Ø 31,8 mm
1330056	Tee   S/S   1½"   Ø 38,1 mm
1310415	Tee   S/S   2"   Ø 50,8 mm
1310409	Tee   S/S   2½"   Ø 63,5 mm
1310451	Tee   S/S   3"   Ø 76,1 mm



## Tee S/S DN

1330042	Tee   S/S   DN25   Ø 28 mm
1330044	Tee   S/S   DN32   Ø 34 mm
1330046	Tee   S/S   DN40   Ø 40 mm
1330048	Tee   S/S   DN50   Ø 52 mm
1330049	Tee   S/S   DN65   Ø 70 mm



## Cross piece S/S

1315088	Cross piece   S/S   Ø 52 mm   DIN11851
---------	--



## Inlet bend

1340465	Inlet bend   for tank   Ø 30 mm   corr. Westfalia 7038-2622-000
---------	---



## S/S tube connector

1311290	Tube connector   S/S   Ø 16 x 1 x 100 mm
1311292	Tube connector   S/S   Ø 18 x 1 x 100 mm
1311294	Tube connector   S/S   Ø 22 x 1 x 50 mm
1311296	Tube connector   S/S   Ø 22 x 1 x 100 mm



## S/S bend 90°

1311532	S/S bend   90°   Ø 14-16 mm
1311534	S/S bend   90°   Ø 16-18 mm
1311536	S/S bend   90°   Ø 20-22 mm



## Clamp bend 45°

<b>1330439</b>	Clamp bend   45°   1½"
<b>1330455</b>	Clamp bend   45°   2"
<b>1330458</b>	Clamp bend   45°   2½"
<b>1330460</b>	Clamp bend   45°   DN40
<b>1330465</b>	Clamp bend   45°   DN50



## Clamp bend 90°

<b>1330446</b>	Clamp bend   90°   1¼"
<b>1330448</b>	Clamp bend   90°   1½"
<b>1330450</b>	Clamp bend   90°   2"
<b>1330456</b>	Clamp bend   90°   2½"
<b>1330457</b>	Clamp bend   90°   3"
<b>1330440</b>	Clamp bend   90°   DN40
<b>1330452</b>	Clamp bend   90°   DN50



## Clamp coupling

<b>1330330</b>	Clamp coupling   Ø 25,4 mm   1"   complete
<b>1330332</b>	Clamp coupling   Ø 38,1 mm   1½"   complete
<b>1330342</b>	Clamp coupling   Ø 40 mm   DN40   complete
<b>1330334</b>	Clamp coupling   Ø 50,8 mm   2"   complete
<b>1330344</b>	Clamp coupling   Ø 52 mm   DN50   complete
<b>1330335</b>	Clamp coupling   Ø 63,5 mm   2½"   complete
<b>1330336</b>	Clamp coupling   Ø 76,2 mm   3"   complete
<b>1330337</b>	Clamp coupling   Ø 101,6 mm   4"   complete



## S/S clamps (ferrules)

<b>1330325</b>	S/S clamps ( ferrules)   Ø 25,4 mm   1"
<b>1330338</b>	S/S clamps ( ferrules)   Ø 38,1 mm   1½"
<b>1330340</b>	S/S clamps ( ferrules)   Ø 40 mm   DN40
<b>1330350</b>	S/S clamps ( ferrules)   Ø 50,8 mm   2"
<b>1330353</b>	S/S clamps ( ferrules)   Ø 52 mm   DN50
<b>1330363</b>	S/S clamps ( ferrules)   Ø 63,5 mm   2½"
<b>1330376</b>	S/S clamps ( ferrules)   Ø 76,2 mm   3"
<b>1330377</b>	S/S clamps ( ferrules)   Ø 101,6 mm   4"



## Gasket

<b>1330022</b>	Gasket for ferrule   Ø 25,4 mm   1"
<b>1330024</b>	Gasket for ferrule   Ø 38,1 mm   1½"   Ø 40 mm   DN40
<b>1330026</b>	Gasket for ferrule   Ø 50,8 mm   2"   Ø 52 mm   DN50
<b>1330028</b>	Gasket for ferrule   Ø 63,5 mm   2½"
<b>1330030</b>	Gasket for ferrule   Ø 76,2 mm   3"
<b>1330032</b>	Gasket for ferrule   Ø 101,6 mm   4"



## Gasket silicone

<b>1330670</b>	Gasket for ferrule   Ø 25,4 mm   1"   silicone
<b>1330672</b>	Gasket for ferrule   Ø 38,1 mm   1½"   Ø 40 mm   DN40   silicone
<b>1330674</b>	Gasket for ferrule   Ø 50,8 mm   2"   Ø 52 mm   DN50   silicone
<b>1330676</b>	Gasket for ferrule   Ø 63,5 mm   2½"   silicone
<b>1330678</b>	Gasket for ferrule   Ø 76,2 mm   3"   silicone
<b>1330680</b>	Gasket for ferrule   Ø 101,6 mm   4"   silicone



## Triclover V-clamp light

<b>1330011</b>	Triclover V-clamp   S/S   light version   Ø 25,4 mm   1"
<b>1330006</b>	Triclover V-clamp   S/S   light version   Ø 38,1 mm   1½"   Ø 40 mm   DN40
<b>1330007</b>	Triclover V-clamp   S/S   light version   Ø 50,8 mm   2"
<b>1330008</b>	Triclover V-clamp   S/S   light version   Ø 63,5 mm   2½"
<b>1330009</b>	Triclover V-clamp   S/S   light version   Ø 76,2 mm   3"
<b>1330010</b>	Triclover V-clamp   S/S   light version   Ø 101,6 mm   4"



## Triclover V-clamp heavy

<b>1330000</b>	Triclover V-clamp   S/S   heavy version   Ø 25,4 mm   1"
<b>1330001</b>	Triclover V-clamp   S/S   heavy version   Ø 38,1 mm   1½"   Ø 40 mm   DN40
<b>1330002</b>	Triclover V-clamp   S/S   heavy version   Ø 50,8 mm   2"
<b>1330003</b>	Triclover V-clamp   S/S   heavy version   Ø 63,5 mm   2½"
<b>1330004</b>	Triclover V-clamp   S/S   heavy version   Ø 76,2 mm   3"
<b>1330005</b>	Triclover V-clamp   S/S   heavy version   Ø 101,6 mm   4"



## S/S milk line coupling

<b>1301072</b>	Coupling   S/S   Ø 32-34 mm
<b>1301083</b>	Coupling   S/S   Ø 38-40 mm
<b>1301084</b>	Coupling   S/S   Ø 50,8-52 mm
<b>1301085</b>	Coupling   S/S   Ø 63,5 mm
<b>1302170</b>	Coupling   S/S   Ø 70 mm
<b>1301086</b>	Coupling   S/S   Ø 76,5 mm
<b>1302175</b>	Coupling   S/S   Ø 102 mm



## Socket white

<b>1301087</b>	Socket   rubber   white   Ø 32-34 mm   1¼"
<b>1301088</b>	Socket   rubber   white   Ø 38-40 mm   1½"
<b>1301089</b>	Socket   rubber   white   Ø 50,8-52 mm   2"
<b>1301090</b>	Socket   rubber   white   Ø 63,5mm   2½"
<b>1301091</b>	Socket   rubber   white   Ø 76,5 mm   3"



## S/S milk line coupling blue

<b>1301095</b>	Coupling   S/S   blue   Ø 38-40 mm
<b>1301096</b>	Coupling   S/S   blue   Ø 50,8-52 mm
<b>1301097</b>	Coupling   S/S   blue   Ø 63,5 mm
<b>1301098</b>	Coupling   S/S   blue   Ø 76,5 mm
<b>1302173</b>	Coupling   S/S   blue   Ø 88,9 mm



## Socket blue

<b>1301108</b>	Socket   rubber   blue   Ø 38-40 mm   1½"
<b>1301101</b>	Socket   rubber   blue   Ø 50-52 mm   2"
<b>1301099</b>	Socket   rubber   blue   Ø 63,5mm   2½"
<b>1301109</b>	Socket   rubber   blue   Ø 76,5 mm   3"
<b>1301118</b>	Socket   rubber   blue   Ø 88,9 mm   length 100 mm



## Nylon coupling

<b>1301104</b>	Coupling   nylon   Ø 40 mm   for S/S tubes
<b>1301106</b>	Coupling   nylon   Ø 50,8 mm   for S/S tubes
<b>1301107</b>	Coupling   nylon   Ø 52 mm   for S/S tubes



## Socket

<b>1301112</b>	Socket   rubber   Ø 40 mm   for S/S tubes
<b>1301114</b>	Socket   rubber   Ø 50,8 mm   for S/S tubes
<b>1301115</b>	Socket   rubber   Ø 52 mm   for S/S tubes



## Expanding coupling inch SMS

<b>1307955</b>	Expanding coupling   S/S   1"   SMS
<b>1307958</b>	Expanding coupling   S/S   1½"   SMS
<b>1307961</b>	Expanding coupling   S/S   2"   SMS
<b>1307964</b>	Expanding coupling   S/S   2½"   SMS
<b>1307965</b>	Expanding coupling   S/S   3"   SMS



## Gasket for expanding coupling inch SMS

<b>1308331</b>	Gasket for coupling SMS   1"
<b>1308332</b>	Gasket for coupling SMS   1½"
<b>1308333</b>	Gasket for coupling SMS   2"
<b>1308334</b>	Gasket for coupling SMS   2½"
<b>1308335</b>	Gasket for coupling SMS   3"



## Expanding coupling inch

<b>1307972</b>	Expanding coupling   S/S   1"   25,4 mm
<b>1307973</b>	Expanding coupling   S/S   1½"   38,1 mm
<b>1307974</b>	Expanding coupling   S/S   2"   50,8 mm
<b>1307975</b>	Expanding coupling   S/S   2½"   63,5 mm
<b>1307976</b>	Expanding coupling   S/S   3"   76,2 mm
<b>1307977</b>	Expanding coupling   S/S   4"   101,6 mm



## Expanding coupling DN

<b>1307950</b>	Expanding coupling   S/S   DN25
<b>1307953</b>	Expanding coupling   S/S   DN32
<b>1307956</b>	Expanding coupling   S/S   DN40
<b>1307959</b>	Expanding coupling   S/S   DN50
<b>1307962</b>	Expanding coupling   S/S   DN65
<b>1310778</b>	Expanding coupling   S/S   DN80
<b>1310780</b>	Expanding coupling   S/S   DN100



## Gasket

<b>1307951</b>	Gasket for coupling   DN25   1"
<b>1307954</b>	Gasket for coupling   DN32   1¼"
<b>1307957</b>	Gasket for coupling   DN40   1½"
<b>1307960</b>	Gasket for coupling   DN50   2"
<b>1307963</b>	Gasket for coupling   DN65   2½"
<b>1310782</b>	Gasket for coupling   DN80   3"
<b>1310785</b>	Gasket for coupling   DN100   4"



## Tool

<b>1314030</b>	Tool   for expanding coupling 25-40 mm
<b>1314040</b>	Tool   for expanding coupling 50-100 mm



## Tube expander inch S/S

<b>1330366</b>	Tube expander   1"
<b>1330354</b>	Tube expander   1¼"
<b>1330364</b>	Tube expander   1½"
<b>1330360</b>	Tube expander   2"
<b>1330362</b>	Tube expander   2½"
<b>1330365</b>	Tube expander   3"



## Tube expander DN S/S

<b>1330345</b>	Tube expander   DN25
<b>1330356</b>	Tube expander   DN32
<b>1330358</b>	Tube expander   DN40
<b>1330361</b>	Tube expander   DN50



## Cutting device inch

<b>1330502</b>	Cutting device   1"
<b>1330504</b>	Cutting device   1¼"
<b>1330506</b>	Cutting device   1½"
<b>1330508</b>	Cutting device   2"
<b>1330510</b>	Cutting device   3"



## Cutting device DN

<b>1330520</b>	Cutting device   DN 25
<b>1330522</b>	Cutting device   DN 32
<b>1330523</b>	Cutting device   DN 40
<b>1330524</b>	Cutting device   DN 50
<b>1330526</b>	Cutting device   DN 65
<b>1330528</b>	Cutting device   DN 80



## Combined clamp- and cutting device DN

<b>1330530</b>	Combined clamp- and cutting device   DN 25
<b>1330532</b>	Combined clamp- and cutting device   DN 32
<b>1330533</b>	Combined clamp- and cutting device   DN 40
<b>1330534</b>	Combined clamp- and cutting device   DN 50
<b>1330536</b>	Combined clamp- and cutting device   DN 65
<b>1330538</b>	Combined clamp- and cutting device   DN 80



## Endcap rubber

<b>1300378</b>	Endcap   rubber   Ø 32 mm
<b>1300379</b>	Endcap   rubber   Ø 38-40 mm
<b>1300380</b>	Endcap   rubber   Ø 50 mm
<b>1300381</b>	Endcap   rubber   Ø 63,5 mm
<b>1300382</b>	Endcap   rubber   Ø 76,2 mm



## Endcap rubber with S/S sprayplate

<b>1300390</b>	Endcap   rubber   Ø 38-40 mm   S/S sprayplate Ø 14-16 mm
<b>1300391</b>	Endcap   rubber   Ø 50 mm   S/S sprayplate Ø 14-16 mm
<b>1300409</b>	Endcap   rubber   Ø 38-40 mm   S/S sprayplate Ø 16-18 mm



## Endcap rubber with S/S tube

<b>1300384</b>	Endcap   rubber   Ø 38-40 mm   S/S tube Ø 14-16 mm
<b>1300385</b>	Endcap   rubber   Ø 50 mm   S/S tube Ø 14-16 mm
<b>1300386</b>	Endcap   rubber   Ø 38-40 mm   S/S tube Ø 16-18 mm
<b>1300387</b>	Endcap   rubber   Ø 50 mm   S/S tube Ø 16-18 mm
<b>1300388</b>	Endcap   rubber   Ø 63,5 mm   S/S tube Ø 16-18 mm
<b>1300389</b>	Endcap   rubber   Ø 76,2 mm   S/S tube Ø 16-18 mm



## Plug

<b>1300394</b>	Plug   rubber   Ø 40 mm
<b>1300395</b>	Plug   conical   Ø 50-52 mm
<b>1309644</b>	Plug   conical   Ø 88-92 mm



## Sealing cap

<b>1300392</b>	Sealing cap   rubber   with chain   corr. Gascoigne Melotte
<b>1306983</b>	Plug   for sealing cap   also fits milk entries Ø 14-16 mm   corr. Gascoigne Melotte





## Butterfly valve S/S

<b>1301223</b>	Butterfly valve   S/S   Ø 40 mm
<b>1301224</b>	Butterfly valve   S/S   Ø 50,8 mm
<b>1307855</b>	Butterfly valve   S/S   Ø 52 mm
<b>1301225</b>	Butterfly valve   S/S   Ø 63 mm
<b>1301226</b>	Butterfly valve   S/S   Ø 76 mm



## Butterfly valve | S/S with handle

<b>1307815</b>	Butterfly valve   S/S   with handle   Ø 40 mm
<b>1307816</b>	Butterfly valve   S/S   with handle   Ø 50,8 mm
<b>1307817</b>	Butterfly valve   S/S   with handle   Ø 52 mm
<b>1307818</b>	Butterfly valve   S/S   with handle   Ø 63 mm
<b>1307819</b>	Butterfly valve   S/S   with handle   Ø 76 mm



## Socket for butterfly valve

<b>1307791</b>	Socket   butterfly valve   40 mm
<b>1307792</b>	Socket   butterfly valve   50,8 mm and 52 mm
<b>1307794</b>	Socket   butterfly valve   63 mm
<b>1307793</b>	Socket   butterfly valve   76 mm



## Butterfly valve rubber

<b>1307079</b>	Butterfly valve   rubber   Ø 40 mm   1½"
<b>1307082</b>	Butterfly valve   rubber   Ø 50 mm   2"
<b>1310675</b>	Repair kit   for butterfly valve Ø 40 mm
<b>1310622</b>	Repair kit   for butterfly valve Ø 50 mm



## Two-way valve white

<b>1301220</b>	Two-way valve   plastic   white   Ø 19 x 16 mm
<b>1301235</b>	Two-way valve   plastic   white   Ø 22 x 19 mm
<b>1308394</b>	Joint   Ø 19 x 16 mm
<b>1311655</b>	O-ring   Ø 19 x 16 mm



## Two-way valve green/blue

<b>1307351</b>	Two-way valve   plastic   green/blue   Ø 10 x 7 mm
<b>1315087</b>	Two-way valve   plastic   green/blue   Ø 14 x 11 mm
<b>1301219</b>	Two-way valve   plastic   green/blue   Ø 16 x 13 mm



## Two- and Three way valve

<b>1301210</b>	Two-way valve   plastic   Ø 40/31 mm
<b>1301211</b>	Two-way valve   plastic   Ø 52/46 mm
<b>1301212</b>	Two-way valve   plastic   Ø 63/54 mm
<b>1301214</b>	Three-way valve   plastic   Ø 40/31 mm
<b>1301215</b>	Three-way valve   plastic   Ø 52/46 mm
<b>1301218</b>	Handle   plastic   for Ø 40 and 52 mm valves



## Bolt saddles

<b>0120538</b>	Bolt saddle   female   40 mm x ½"
<b>0120539</b>	Bolt saddle   female   40 mm x ¾"
<b>0120540</b>	Bolt saddle   female   40 mm x 1"
<b>0120548</b>	Bolt saddle   female   50 mm x ½"
<b>0120549</b>	Bolt saddle   female   50 mm x ¾"
<b>0120550</b>	Bolt saddle   female   50 mm x 1"
<b>0120551</b>	Bolt saddle   female   50 mm x 1¼"
<b>0120563</b>	Bolt saddle   female   63 mm x ½"
<b>0120564</b>	Bolt saddle   female   63 mm x ¾"
<b>0120565</b>	Bolt saddle   female   63 mm x 1"
<b>0120566</b>	Bolt saddle   female   63 mm x 1¼"
<b>0120567</b>	Bolt saddle   female   63 mm x 1½"
<b>0120575</b>	Bolt saddle   female   75 mm x ½"
<b>0120576</b>	Bolt saddle   female   75 mm x ¾"
<b>0120577</b>	Bolt saddle   female   75 mm x 1"
<b>0120578</b>	Bolt saddle   female   75 mm x 1¼"
<b>0120579</b>	Bolt saddle   female   75 mm x 1½"
<b>0120580</b>	Bolt saddle   female   75 mm x 2"
<b>0120590</b>	Bolt saddle   female   90 mm x ½"
<b>0120591</b>	Bolt saddle   female   90 mm x ¾"
<b>0120592</b>	Bolt saddle   female   90 mm x 1"
<b>0120593</b>	Bolt saddle   female   90 mm x 1¼"
<b>0120594</b>	Bolt saddle   female   90 mm x 1½"



<b>0120595</b>	Bolt saddle   female   90 mm x 2"
<b>0120609</b>	Bolt saddle   female   110 mm x ½"
<b>0120610</b>	Bolt saddle   female   110 mm x ¾"
<b>0120611</b>	Bolt saddle   female   110 mm x 1"
<b>0120612</b>	Bolt saddle   female   110 mm x 1¼"
<b>0120613</b>	Bolt saddle   female   110 mm x 1½"
<b>0120614</b>	Bolt saddle   female   110 mm x 2"

## Vacuum valve

<b>0100856</b>	Vacuum valve   PVC   1½"   50 mm
<b>0100857</b>	Vacuum valve   PVC   2"   63 mm
<b>0100885</b>	Vacuum valve   PVC   2½"   75 mm
<b>1307199</b>	Vacuum valve   PVC   3"   90 mm
<b>0100859</b>	Vacuum valve   PVC   4"   110 mm



## Vacuum valve white imperial

<b>1301965</b>	Vacuum valve   PVC   white imperial   2" (+/- 60,3 mm)
<b>1301966</b>	Vacuum valve   PVC   white imperial   3" (+/- 88,5 mm)



## Pipe clamp Easy Click

<b>1309425</b>	Pipe clamp   plastic   "Easy Click"   without clip   Ø 25 mm
<b>1309432</b>	Pipe clamp   plastic   "Easy Click"   without clip   Ø 32 mm
<b>1309440</b>	Pipe clamp   plastic   "Easy Click"   Ø 40 mm
<b>1309450</b>	Pipe clamp   plastic   "Easy Click"   Ø 50 mm
<b>1309463</b>	Pipe clamp   plastic   "Easy Click"   Ø 63 mm
<b>1309475</b>	Pipe clamp   plastic   "Easy Click"   Ø 75 mm
<b>1309490</b>	Pipe clamp   plastic   "Easy Click"   Ø 90 mm



## Pipe clamp

<b>0110950</b>	Pipe clamp   plastic   without clip   Ø 16 mm
<b>0110951</b>	Pipe clamp   plastic   without clip   Ø 20 mm
<b>0110952</b>	Pipe clamp   plastic   without clip   Ø 25 mm
<b>0110953</b>	Pipe clamp   plastic   without clip   Ø 32 mm
<b>0110954</b>	Pipe clamp   plastic   Ø 40 mm
<b>0110955</b>	Pipe clamp   plastic   Ø 50 mm
<b>0110956</b>	Pipe clamp   plastic   Ø 63 mm
<b>0110957</b>	Pipe clamp   plastic   Ø 75 mm
<b>0110958</b>	Pipe clamp   plastic   Ø 90 mm
<b>0110959</b>	Pipe clamp   plastic   Ø 110 mm



## Pipe clamp with 1/2" thread

<b>1301580</b>	Pipe clamp   black   1"
<b>1301581</b>	Pipe clamp   black   1½"
<b>1301582</b>	Pipe clamp   black   2"
<b>1301583</b>	Pipe clamp   black   2½"
<b>1301584</b>	Pipe clamp   black   3"



## Accessories for pipe clamps

<b>1301586</b>	Screw   S/S   cross head   25 x 6,3 mm
<b>1301587</b>	Rubber profile   29 x 34 x 3 mm   5 mtr/coil
<b>1307035</b>	Tube holder   black   ½" thread



## Mini ball valve

<b>0091016</b>	Mini ball valve   S/S   ¼"   female x male
<b>0091017</b>	Mini ball valve   S/S   ⅜"   female x male
<b>0091018</b>	Mini ball valve   S/S   ½"   female x male
<b>0091019</b>	Mini ball valve   S/S   ¼"   female x female
<b>0091020</b>	Mini ball valve   S/S   ⅜"   female x female
<b>0091021</b>	Mini ball valve   S/S   ½"   female x female



## Ball valve

0090892	Ball valve	S/S	1-piece	¼"	light model
0090893	Ball valve	S/S	1-piece	⅜"	light model
0090894	Ball valve	S/S	1-piece	½"	light model
0090895	Ball valve	S/S	1-piece	¾"	light model
0090896	Ball valve	S/S	1-piece	1"	light model
0090897	Ball valve	S/S	1-piece	1¼"	light model
0090898	Ball valve	S/S	1-piece	1½"	light model
0090899	Ball valve	S/S	1-piece	2"	light model



## Ball valve brass with steel lever

0403000	Ball valve	brass	Mega 100	¼"
0403001	Ball valve	brass	Mega 100	⅜"
0403002	Ball valve	brass	Mega 100	½"
0403003	Ball valve	brass	Mega 100	¾"
0403004	Ball valve	brass	Mega 100	1"
0403005	Ball valve	brass	Mega 100	1¼"
0403006	Ball valve	brass	Mega 100	1½"
0403007	Ball valve	brass	Mega 100	2"
0403008	Ball valve	brass	Mega 100	2½"
0403009	Ball valve	brass	Mega 100	3"
0403010	Ball valve	brass	Mega 100	4"



## Ball valve brass with S/S lever

0403030	Ball valve	brass	Mega 100VA	¼"
0403031	Ball valve	brass	Mega 100VA	⅜"
0403032	Ball valve	brass	Mega 100VA	½"
0403033	Ball valve	brass	Mega 100VA	¾"
0403034	Ball valve	brass	Mega 100VA	1"
0403035	Ball valve	brass	Mega 100VA	1¼"
0403036	Ball valve	brass	Mega 100VA	1½"
0403037	Ball valve	brass	Mega 100VA	2"



## Drain valve plastic

1301361	Drain valve	plastic	½" BSP
---------	-------------	---------	--------



## Drain valve plastic corr. DeLaval

**1307061** Drain valve | plastic | 3/8" BSP | corr. DeLaval 964.516-80



## Drain valve nickel plated

**1301360** Drain valve | nickel plated | 1/2" BSP



## Drain valve rubber corr. DeLaval

**1301363** Drain valve | rubber | corr. DeLaval 957.845-01



## Drain valve rubber corr. Gascoigne Melotte

**1301359** Drain valve | rubber | corr. Gascoigne Melotte D255028 and 381-095



## Drain valve corr. Westfalia

**1316470** Drain valve | Ø 16 mm | corr. Westfalia 7047-1935-010



## Socket PVC

**0110616** Socket | PVC | Ø 32 mm | 16 bar

**0110617** Socket | PVC | Ø 40 mm | 16 bar

**0110618** Socket | PVC | Ø 50 mm | 16 bar

**0110619** Socket | PVC | Ø 63 mm | 16 bar

**0110652** Socket | PVC | Ø 75 mm | 16 bar

**0110653** Socket | PVC | Ø 90 mm | 16 bar

**0110654** Socket | PVC | Ø 110 mm | 16 bar

**0110657** Socket | PVC | Ø 160 mm | 16 bar



## Reduction socket PVC

<b>0110669</b>	Reduction socket	PVC	Ø 63 x 50 mm	12,5 bar
<b>0110670</b>	Reduction socket	PVC	Ø 75 x 50 mm	7,5 bar
<b>0110671</b>	Reduction socket	PVC	Ø 75 x 63 mm	12,5 bar
<b>0110672</b>	Reduction socket	PVC	Ø 90 x 50 mm	12,5 bar
<b>0110673</b>	Reduction socket	PVC	Ø 90 x 63 mm	10 bar
<b>0110674</b>	Reduction socket	PVC	Ø 90 x 75 mm	12,5 bar



## Reduction socket PVC

<b>0110719</b>	Reduction socket	PVC	Ø 75/63 x 40 mm	16 bar
<b>0110720</b>	Reduction socket	PVC	Ø 75/63 x 50 mm	16 bar
<b>0110721</b>	Reduction socket	PVC	Ø 90/75 x 50 mm	16 bar
<b>0110722</b>	Reduction socket	PVC	Ø 90/75 x 63 mm	16 bar
<b>0110723</b>	Reduction socket	PVC	Ø 110/90 x 63 mm	16 bar



## Tee PVC

<b>0110245</b>	Tee	PVC	Ø 32 mm	16 bar	90°
<b>0110246</b>	Tee	PVC	Ø 40 mm	16 bar	90°
<b>0110247</b>	Tee	PVC	Ø 50 mm	16 bar	90°
<b>0110248</b>	Tee	PVC	Ø 63 mm	16 bar	90°
<b>0110258</b>	Tee	PVC	Ø 75 mm	16 bar	90°
<b>0110259</b>	Tee	PVC	Ø 90 mm	16 bar	90°
<b>0110260</b>	Tee	PVC	Ø 110 mm	16 bar	90°
<b>0110263</b>	Tee	PVC	Ø 160 mm	16 bar	90°



## Elbow 45° PVC

<b>0110122</b>	Elbow	PVC	Ø 32 mm	16 bar	45°
<b>0110123</b>	Elbow	PVC	Ø 40 mm	16 bar	45°
<b>0110124</b>	Elbow	PVC	Ø 50 mm	16 bar	45°
<b>0110125</b>	Elbow	PVC	Ø 63 mm	16 bar	45°
<b>0110126</b>	Elbow	PVC	Ø 75 mm	16 bar	45°
<b>0110127</b>	Elbow	PVC	Ø 90 mm	16 bar	45°



## Elbow 90° | PVC

<b>0110100</b>	Elbow	PVC	Ø 32 mm	16 bar	90°
<b>0110101</b>	Elbow	PVC	Ø 40 mm	16 bar	90°
<b>0110102</b>	Elbow	PVC	Ø 50 mm	16 bar	90°
<b>0110103</b>	Elbow	PVC	Ø 63 mm	16 bar	90°
<b>0110112</b>	Elbow	PVC	Ø 75 mm	16 bar	75°
<b>0110113</b>	Elbow	PVC	Ø 90 mm	16 bar	90°
<b>0110117</b>	Elbow	PVC	Ø 160 mm	16 bar	90°



## Bend PVC

<b>0110178</b>	Bend	PVC	Ø 25 mm	16 bar	90°	injection moulded
<b>0110179</b>	Bend	PVC	Ø 32 mm	16 bar	90°	injection moulded
<b>0110180</b>	Bend	PVC	Ø 40 mm	16 bar	90°	injection moulded
<b>0110181</b>	Bend	PVC	Ø 50 mm	16 bar	90°	injection moulded
<b>0110182</b>	Bend	PVC	Ø 63 mm	16 bar	90°	injection moulded
<b>0110183</b>	Bend	PVC	Ø 75 mm	16 bar	90°	injection moulded
<b>0110184</b>	Bend	PVC	Ø 90 mm	16 bar	90°	injection moulded
<b>0110185</b>	Bend	PVC	Ø 110 mm	16 bar	90°	injection moulded
<b>0110188</b>	Bend	PVC	Ø 32 mm	10 bar	90°	hand-formed
<b>0110189</b>	Bend	PVC	Ø 40 mm	10 bar	90°	hand-formed
<b>0110190</b>	Bend	PVC	Ø 50 mm	10 bar	90°	hand-formed
<b>0110191</b>	Bend	PVC	Ø 63 mm	10 bar	90°	hand-formed
<b>0110192</b>	Bend	PVC	Ø 75 mm	10 bar	90°	hand-formed
<b>0110193</b>	Bend	PVC	Ø 90 mm	10 bar	90°	hand-formed
<b>0110194</b>	Bend	PVC	Ø 110 mm	12,5 bar	90°	hand-formed
<b>0110196</b>	Bend	PVC	Ø 160 mm	12,5 bar	90°	hand-formed



## Cap PVC

<b>0110588</b>	Cap	PVC	Ø 32 mm	16 bar
<b>0110589</b>	Cap	PVC	Ø 40 mm	16 bar
<b>0110590</b>	Cap	PVC	Ø 50 mm	16 bar
<b>0110591</b>	Cap	PVC	Ø 63 mm	16 bar
<b>0110592</b>	Cap	PVC	Ø 75 mm	16 bar
<b>0110593</b>	Cap	PVC	Ø 90 mm	16 bar





## PVC insulation tape

0070001	Insulation tape   PVC   5 cm   yellow
0070002	Insulation tape   PVC   5 cm   white
0070003	Insulation tape   PVC   5 cm   grey
0070004	Insulation tape   PVC   5 cm   black



## Seal tape

0070013	Seal tape   PTFE GASTEC   12 mtr
0070011	Seal tape   PTFE   10 mtr
0070062	Seal tape   PTFE   25 mtr
0070063	Seal tape   PTFE   50 mtr



## Thread sealant

0070045	Tangit   Uni-Lock   thread sealant
---------	------------------------------------



## Glue

0146020	Tangit   All Pressure glue   125 gr
0146021	Tangit   All Pressure glue   240 gr
0146025	Tangit   All Pressure glue   480 gr
0146023	Tangit   All Pressure glue   960 gr



## Cleaner

0146026	Tangit   cleaner   125 ml
0146027	Tangit   cleaner   1 ltr.



## Non return valve horizontal brass

<b>0410609</b>	Non return valve   horizontal   brass   type 790 3/8"
<b>0410612</b>	Non return valve   horizontal   brass   type 790 1/2"
<b>0410618</b>	Non return valve   horizontal   brass   type 790 3/4"
<b>0410625</b>	Non return valve   horizontal   brass   type 790 1"
<b>0410632</b>	Non return valve   horizontal   brass   type 790 1 1/4"
<b>0410640</b>	Non return valve   horizontal   brass   type 790 1 1/2"
<b>0410650</b>	Non return valve   horizontal   brass   type 790 2"



## Non return valve brass

<b>0405106</b>	Non return valve   brass   type Europa 100   1/2"
<b>0405107</b>	Non return valve   brass   type Europa 100   3/4"
<b>0405108</b>	Non return valve   brass   type Europa 100   1"
<b>0405109</b>	Non return valve   brass   type Europa 100   1 1/4"
<b>0405110</b>	Non return valve   brass   type Europa 100   1 1/2"
<b>0405111</b>	Non return valve   brass   type Europa 100   2"
<b>0405112</b>	Non return valve   brass   type Europa 100   2 1/2"



## Brass ball float valve

<b>1200162</b>	Ball float valve   brass   1"
<b>1200163</b>	Ball float valve   brass   1 1/4"
<b>1200164</b>	Ball float valve   brass   1 1/2"



## Float

<b>1200167</b>	Float   plastic   for 3/4"-1" x M8 ball float valve   Ø 120 mm
<b>1200168</b>	Float   plastic   for 1"-1 1/4"-1 1/2" x M8 ball float valve   Ø 150 mm
<b>1200169</b>	Float   plastic   for 1 1/4"-1 1/2"-2" x M8 ball float valve   Ø 180 mm



## Vacuum valve right-angled

<b>1300880</b>	Vacuum valve   right-angled   90°   1/2" BSP connection
----------------	---



## Vacuum valve straight

<b>1300881</b>	Vacuum valve   straight   ½" BSP connection
<b>1300875</b>	Vacuum valve   straight   ¾" BSP connection



## Vacuum clamp valve right-angled 90°

<b>1300882</b>	Vacuum clamp valve   right-angled   90°   ¾"-1"   including rubber gasket
<b>1300883</b>	Vacuum clamp valve   right-angled   90°   1¼"-1½"   including rubber gasket



## Vacuum clamp valve

<b>1300884</b>	Vacuum clamp valve   1¼"-1½"   ½" BSP connection   including rubber gasket
<b>1300885</b>	Vacuum clamp valve   2"   ½" BSP connection   including rubber gasket



## Vacuum valve

<b>1300886</b>	Vacuum valve   with pipe clamp   1¼"-1½"   including gasket
<b>1300887</b>	Vacuum valve   with pipe clamp   ¾"-1"   including gasket



## Vacuum valve connecting tube

<b>1300889</b>	Vacuum valve   connecting tube   complete
<b>1310836</b>	Connecting tube
<b>1300891</b>	Spring
<b>1300890</b>	Gasket   24 x 12 x 4 mm



## Gasket for vacuum valves

<b>1300888</b>	Gasket   for several vacuum valves
----------------	------------------------------------





Chapter 4

# PULSATION



## Chapter 4 Pulsation

Pulsator Nedlac blue	P85
Pulsator Nedlac green	P85
Pulsator Nedlac S/S	P85
Pulsator Nedlac for sheep and goats	P85
Repair kit for Nedlac pulsator	P85
Parts for Nedlac pulsator	P86
LL90 pulsator	P86
Repair kit for LL90 pulsator	P86
Parts for L80 / LL90 pulsator	P87
Repair kit for L80 pulsator	P87
Pulsator L02	P87
Electric pulsator	P87
Pulsator LE20	P87
Pulsator LP20	P88
Repair kit for LE/LP20 pulsator	P88
Pulsator corr. DeLaval EP100	P88
Repair kit corr. DeLaval EP100	P88
Coils corr. DeLaval EP100	P88
Parts corr. DeLaval EP100	P89
Rubber valve	P89
Diaphragm corr. DeLaval and SAC	P89
Diaphragm corr. DeLaval HP100	P89
Diaphragm corr. DeLaval	P89
Electronic pulsator	P90
Electronic pulsator Strangko	P90
Repair kit corr. Boumatic pulsator	P90
Repair kit Hi-Flo Evolution corr. Boumatic pulsator	P90
Pulsator kit corr. Dairymaster P216	P90
Pulsator kit corr. Dairymaster P511	P90
Diaphragm corr. Dairymaster	P90
Diaphragm corr. Gascoigne Melotte	P91
Coil corr. DeLaval AMR	P91
Filters corr. GEA	P91
Repair kit corr. Fullwood Master Relay	P91
Vacuum valve	P91
O-ring corr. Manus and Lely	P91
Pulsation tester	P92
Sensor for PT-V	P92

Vacroscope and Aeroscope	P92
Adapter corr. DeLaval for plastic lid	P92
Adapter corr. DeLaval	P93
Adapter corr. Fullwood for lid	P93
Adapter corr. Fullwood for pipeline	P93
Adapter corr. Gascoigne Melotte for lid	P93
Adapter corr. Gascoigne Melotte new model	P93
Adapter corr. Gascoigne Melotte old model	P93
Adapter corr. Gascoigne Melotte	P93
Adapter corr. DeLaval / Manus	P94
Adapter corr. Miele including valve	P94
Adapter corr. Miele	P94
Adapter corr. Westfalia new model	P94
Adapter corr. Westfalia old model	P94
Adapter corr. Westfalia	P94
Adapter universal	P94
O-rings	P94

## Pulsator Nedlac blue

<b>1308347</b>	Pulsator   Nedlac 2000   blue lid   60:40
<b>1310739</b>	Pulsator   Nedlac 2000   blue lid   50:50
<b>1310244</b>	Pulsator   Nedlac 2000   blue lid   65:35

*Also available in 70:30*



## Pulsator Nedlac green

<b>1310411</b>	Pulsator   Nedlac 2000   green lid   60:40
----------------	--

*Also available in 50:50 and 65:35 and 70:30*



## Pulsator Nedlac S/S

<b>1309857</b>	Pulsator   Nedlac 2000   S/S lid   60:40
<b>1310241</b>	Pulsator   Nedlac 2000   S/S lid   50:50
<b>1310242</b>	Pulsator   Nedlac 2000   S/S lid   65:35
<b>1311479</b>	Pulsator   Nedlac 2000   S/S lid   70:30



## Pulsator Nedlac for sheep and goats

<b>1311475</b>	Pulsator   Nedlac   blue lid   60:40   90 beats   goats
<b>1311477</b>	Pulsator   Nedlac   blue lid   60:40   120 beats   sheep
<b>1311478</b>	Pulsator   Nedlac   blue lid   50:50   120 beats   sheep



## Repair kit for Nedlac pulsator

<b>1310136</b>	Repair kit   Nedlac pulsator   9-pieces   60:40
<b>1341200</b>	Repair kit   Nedlac pulsator   9-pieces   65:35





## Parts for Nedlac pulsator

<b>1309604</b>	Filter
<b>1309605</b>	Large slide   60:40
<b>1309989</b>	Large slide   65:35
<b>1309988</b>	Large slide   70:30
<b>1309712</b>	Diaphragm   large
<b>1309713</b>	Diaphragm   small
<b>1310135</b>	O-ring
<b>1309762</b>	Valve plate
<b>1300127</b>	Gasket   for valve plate
<b>1309606</b>	Slide   large
<b>1300141</b>	Slide   small

*Other parts for the Nedlac pulsator available on request*



## LL90 pulsator

<b>1300164</b>	Pulsator   LL90   60:40
<b>1308295</b>	Pulsator   LL90   60:40   simultaneous
<b>1309595</b>	Pulsator   LL90   65:35
<b>1300165</b>	Pulsator   LL90   70:30



## Repair kit for LL90 pulsator

<b>1309639</b>	Repair kit   LL90 pulsator   60:40
<b>1310870</b>	Repair kit   LL90 pulsator   60:40   simultaneous
<b>1309641</b>	Repair kit   LL90 pulsator   65:35



## Parts for L80 / LL90 pulsator

<b>1300169</b>	Filter
<b>1300171</b>	Slide   60:40
<b>1300170</b>	Slide   50:50
<b>1300172</b>	Slide   65:35
<b>1300173</b>	Slide   70:30
<b>1307401</b>	4 Exits
<b>1300127</b>	Gasket
<b>1300132</b>	Diaphragm   large
<b>1300139</b>	Diaphragm   small
<b>1300137</b>	Slide   large
<b>1300141</b>	Slide   small
<b>1300140</b>	Slide   small
<b>1300144</b>	O-ring

*Other parts for the LL90 pulsator available on request*



## Repair kit for L80 pulsator

<b>1300146</b>	Repair kit   L80 pulsator   60:40
----------------	-----------------------------------



## Pulsator L02

<b>1309645</b>	Air pulsator   L02   60:40
<b>1309646</b>	Air pulsator   L02   70:30

*Other parts for the L02 air pulsator available on request*



## Electric pulsator

<b>1310272</b>	Electric pulsator   24V DC   2 exits   without pulsation PCB
<b>1310275</b>	Electric pulsator   24V DC   2 exits   pulsation PCB



## Pulsator LE20

<b>1308688</b>	Pulsator   LE20   24V   2 exits   filter   without pulsation PCB
<b>1311287</b>	Pulsator   LE20   12V   2 exits   without filter   without pulsation PCB

*All types are available*



## Pulsator LP20

**1308247** Pulsator | LP20 | 24V | 4 exits | filter | pulsation PCB

*All types are available*



## Repair kit for LE/LP20 pulsator

**1308246** Repair kit | LE/LP 20 | corr. Fullwood Legato F42-924

**1312090** Main piston | LE/LP 20 | corr. Fullwood Legato F42-924



## Pulsator corr. DeLaval EP100

**1311632** Electronic pulsator | 12V | corr. DeLaval EP100 966.790-83



## Repair kit corr. DeLaval EP100

**1311639** Repair kit | 12-pieces | new model | corr. DeLaval EP100 999.253-80

**1311641** Repair kit | 12-pieces | old model | corr. DeLaval EP100 999.262-80

**1311643** Repair kit | 2-pieces | new model | corr. DeLaval EP100 985.390-80

**1310423** Repair kit | 2-pieces | old model | corr. DeLaval EP100 984.781-80



## Coils corr. DeLaval EP100

**1311627** Coil | 12V-2,8W | black | corr. DeLaval EP100 997.532-80

**1311628** Coil | 24V-2W | blue | corr. DeLaval EP100

**1311677** Coil | 24V-3,6W | red | corr. DeLaval EP100

**1311673** Coil | 24V-2,7W | yellow | robot | corr. DeLaval AMR 852772-80

**1311634** O-ring | coil | corr. DeLaval EP100 223.403-17



## Parts corr. DeLaval EP100

<b>1311629</b>	Magnetic plate   corr. DeLaval EP100 999.865-01
<b>1311606</b>	Base plate   corr. DeLaval EP100 995.259-82
<b>1311690</b>	Lid   corr. DeLaval EP100
<b>1311685</b>	Gasket   blue   corr. DeLaval EP100
<b>1334030</b>	Piston   corr. DeLaval EP100
<b>1334025</b>	Ring   silicone   small   blue   corr. DeLaval EP100
<b>1311679</b>	Housing   corr. DeLaval EP100
<b>1311681</b>	Cable set   corr. DeLaval EP100
<i>Other parts fitted for the EP100 pulsator available on request</i>	



## Rubber valve

<b>1309775</b>	Valve   rubber   bottom   corr. Manus 9540077
<b>1309776</b>	Valve   rubber   top   corr. Manus 9540076



## Diaphragm corr. DeLaval and SAC

<b>1300309</b>	Diaphragm   Ø 56 mm   corr. DeLaval HP87 and SAC 12328
----------------	--



## Diaphragm corr. DeLaval HP100

<b>1300310</b>	Diaphragm   Ø 56 mm   corr. DeLaval HP100 958.507-01
----------------	--



## Diaphragm corr. DeLaval

<b>1311082</b>	Diaphragm   vacuum amplifier   corr. DeLaval 958.689-01
----------------	---



## Electronic pulsator

<b>1300257</b>	Electronic pulsator   24V DEC   red   fresh air
<b>1300255</b>	Electronic pulsator   24V DEC   red
<b>1300262</b>	Repair kit
<b>1300268</b>	Protector for front nipples
<b>1307392</b>	Fresh air inlet
<b>1300283</b>	Filter for fresh air inlet   90 x 100 mm   complete
<b>1300284</b>	Filter   only



## Electronic pulsator Strangko

<b>1301208</b>	Electronic pulsator   24V   red   Strangko
<b>1300261</b>	Repair kit



## Repair kit corr. Boumatic pulsator

<b>1300265</b>	Repair kit   5-pieces   new model   corr. Boumatic pulsator
----------------	---



## Repair kit Hi-Flo Evolution corr. Boumatic pulsator

<b>1312240</b>	Repair kit   corr. Boumatic Hi-Flo Evolution pulsator
----------------	---



## Pulsator kit corr. Dairymaster P216

<b>1316300</b>	Pulsator kit   corr. Dairymaster P216
----------------	---------------------------------------



## Pulsator kit corr. Dairymaster P511

<b>1316305</b>	Pulsator kit   corr. Dairymaster P511
----------------	---------------------------------------

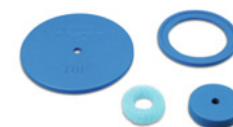

## Diaphragm corr. Dairymaster

<b>1316310</b>	Diaphragm   corr. Dairymaster CR203 and DL32
----------------	--



## Diaphragm corr. Gascoigne Melotte

<b>1309727</b>	Diaphragm set corr. Lectron TL Gascoigne Melotte 255.654
<b>1310380</b>	Diaphragm



## Coil corr. DeLaval AMR

<b>1311673</b>	Coil   24V-2,7W   yellow   robot   corr. DeLaval AMR 852772-80
----------------	--



## Filters corr. GEA

<b>1300315</b>	Filters   12 pieces   corr. GEA Constant-Pulsator 7041-2799-070
----------------	---



## Repair kit corr. Fullwood Master Relay

<b>1309728</b>	Service kit   master relay   corr. 043421
<b>1310139</b>	Filter   blue   corr. Fullwood 43396
<b>1309845</b>	Valve   rubber   corr. Fullwood 42237
<b>1309846</b>	Diaphragm   silicone   corr. Fullwood 43414
<b>1309847</b>	Gasket   corr. Fullwood 43382
<b>1309729</b>	Valve   steel   corr. Fullwood 043027



## Vacuum valve

<b>1307764</b>	Vacuum valve   12W-12V   =DC   corr. Miele
<b>1307765</b>	Coil   12W-12V   =DC
<b>1330012</b>	Set sliding foil

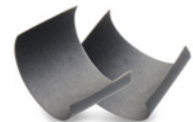

## O-ring corr. Manus and Lely

<b>1309795</b>	O-ring   pulsator   corr. Manus and Lely
----------------	--



## Pulsation tester

<b>1312500</b>	Pulsation tester   PT-VI   basic model   2 internal sensors
<b>1312505</b>	Protection case   PT-VI   with space for the Airflow-meter and parts
<b>1312515</b>	Protection case   PT-VI Milan   blue
<b>1312516</b>	Four-point strap   for protection case PT-VI
<b>1312517</b>	Protection case   silicone   grey   for PT-VI   including four-point strap
<b>1312518</b>	Protection case   silicone   red   for PT-VI   including four-point strap
<b>1312510</b>	Milk line Slug Dynamics App
<b>1308044</b>	Airflow meter   3000 ltr.   for PT-V and PT-VI
<b>1308242</b>	Bypass for airflow meter   for 2000 ltr. extra   for PT-IV, V, VI and 1311215
<b>1309670</b>	Socket   for airflow meter   Ø 46/32 mm
<b>1309669</b>	Socket   for airflow meter   Ø 46/38 mm
<b>1309668</b>	Socket   for airflow meter   Ø 46/46 mm
<i>Several parts and apps available on request</i>	



## Sensor for PT-V

<b>1309673</b>	Sensor   S/S   cleanable   for PT-V
----------------	-------------------------------------



## Vacroscope and Aeroscope

<b>1308354</b>	Vacroscope II   including case
<b>1311015</b>	Airflowmeter   Aeroscope



## Adapter corr. DeLaval for plastic lid

<b>1300195</b>	Adapter   for plastic lid   fitt. DeLaval
----------------	---



## Adapter corr. DeLaval

<b>1300194</b>	Adapter   for S/S lid   corr. DeLaval
<b>1301373</b>	Ring for adapter   corr. DeLaval 956.374-01
<b>1307400</b>	Adapter valve for adapter 1300194 and 1300198
<b>1301372</b>	Non-return valve   corr. DeLaval 2634300
<b>1300214</b>	Gasket for slide side   long   26 x 25,4 mm
<b>1300223</b>	Gasket for slide side   short   16 x 25,4 mm



## Adapter corr. Fullwood for lid

<b>1300204</b>	Adapter   corr. Fullwood
----------------	--------------------------



## Adapter corr. Fullwood for pipeline

<b>1300205</b>	Adapter   corr. Fullwood
----------------	--------------------------



## Adapter corr. Gascoigne Melotte for lid

<b>1300200</b>	Adapter   corr. Gascoigne Melotte lid (art. 1301402)
----------------	--



## Adapter corr. Gascoigne Melotte new model

<b>1300202</b>	Adapter   new model   corr. Gascoigne Melotte
----------------	---



## Adapter corr. Gascoigne Melotte old model

<b>1300203</b>	Adapter   old model   corr. Gascoigne Melotte
----------------	---

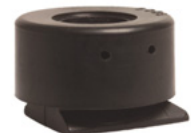

## Adapter corr. Gascoigne Melotte

<b>1300211</b>	Adapter   corr. Gascoigne Melotte
----------------	-----------------------------------





## Adapter corr. DeLaval / Manus

**1300197** Adapter | bayonet connection | corr. DeLaval / Manus



## Adapter corr. Miele including valve

**1300198** Adapter | including valve | corr. Miele

**1307400** Valve



## Adapter corr. Miele

**1300199** Adapter | corr. Miele lid Export



## Adapter corr. Westfalia new model

**1300206** Adapter | new model | corr. Westfalia



## Adapter corr. Westfalia old model

**1300207** Adapter | old model | corr. Westfalia



## Adapter corr. Westfalia

**1300208** Adapter | corr. Westfalia | for S/S milk tubes



## Adapter universal

**1300210** Adapter | universal | for mini milker



## O-rings

**1300217** O-ring | rubber | for adapter | Ø 22 x 3,5 mm

**1300220** O-ring | rubber | for adapter | Ø 26 x 2,5 mm

**1300218** O-ring | rubber | for adapter | Ø 31,5 x 3,63 mm

**1300219** O-ring | rubber | for adapter | Ø 36,5 x 3,5 mm

**1300216** O-ring | rubber | for adapter | Ø 45 x 2,5 mm



Chapter 5

# VACUUM

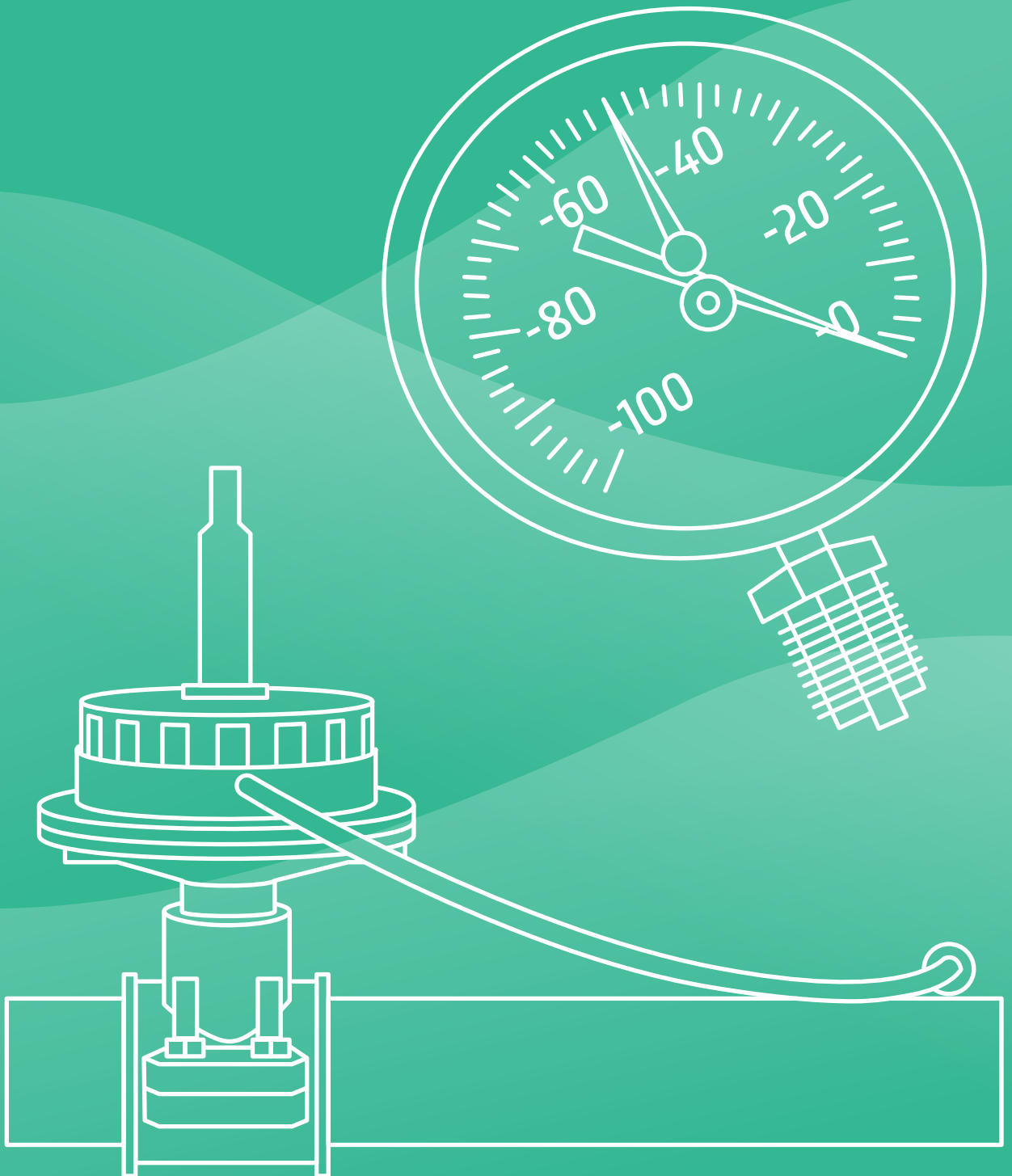

## Chapter 5 Vacuum

Vacuum pump with tank	P97
Vacuum pump with console	P97
Vacuum pump only	P97
Vacuum pump corr. DeLaval	P98
Vacuum pump corr. Fullwood	P98
Vacuum pump with tank	P98
Mobile vacuum pump	P98
Oil separator	P98
Parts for GPV vacuum pump	P98
Silencer	P98
Silencer corr. Fullwood	P99
Oiler corr. DeLaval	P99
Oil keeper universal	P99
Oil keeper double	P99
Oil keeper for GPV Vacuum pump	P99
Vanes Kevlar	P99
Vanes corr. DeLaval Celeron	P100
Vanes corr. Fullwood Celeron	P100
Vanes corr. SAC Celeron	P100
Vanes corr. Westfalia Celeron	P100
Vanes	P101
Vanes graphite	P101
Vacuum regulator corr. Servac	P101
Vacuum regulator 7000 ltr. corr. Servac	P102
Vacuum regulator corr. Gascoigne Melotte	P102
Vacuum regulator corr. M-Tec	P103
Vacuum regulator	P103
Vacuum regulator corr. Westfalia Vacurex	P103
Vacuum-spring regulator plastic	P103
Vacuum-spring regulator brass	P103
Vacuum-spring regulator brass	P104
Vacuum regulator Sentinel Mark II	P104
Vacuum regulator Sentinel Mark	P104
Filter corr. Westfalia Vacurex	P104
VRS sponge filter corr. DeLaval	P104
VRS spring corr. DeLaval	P104
Parts corr. Westfalia / Surge Commander	P105
Filters Surge	P105

Vacuum meter Ø 63 mm	P105
Vacuum meter Ø 100 mm	P105
Vacuum meter Ø 100 mm S/S	P105
Vacuum meter Ø 63 mm back connection	P105
Vacuum meter Ø 63 mm glycerin	P106
Vacuum meter Ø 100 mm glycerin	P106
Vacuum meter Ø 160 mm glycerin	P106
Vacuum meter S/S Ø 80 mm adjustable	P106
Vacuum meter Ø 100 mm adjustable	P106
Vacuum meter S/S Ø 100 mm adjustable	P106
Vacuum tester	P106
Vacuum valve right-angled	P107
Vacuum valve straight	P107
Vacuum clamp valve right-angled 90°	P107
Vacuum clamp valve	P107
Vacuum valve	P107
Connecting tube vacuum valve	P107
Gasket for vacuum valves	P107
Vacuum valve	P108
Vacuum valve white Imperial	P108
Vacuum balance tank green/blue	P108
Vacuum balance tank white	P108
Outlet for vacuum balance tank	P108
Moisture trap	P109
Airflow meter	P109
Airflow meter AFM	P109
Drain valve corr. Dairymaster	P109
Air filter corr. Dairymaster	P109
Gasket corr. Gascoigne Melotte	P109

## Vacuum pump with tank

<b>1310450</b>	Vacuum pump   110 ltr. tank   3300 ltr./min.   10 HP
<b>1310433</b>	Vacuum pump   85 ltr. tank   2300 ltr./min.   10 HP
<b>1310432</b>	Vacuum pump   85 ltr. tank   2000 ltr./min.   5,5 HP
<b>1310431</b>	Vacuum pump   85 ltr. tank   1800 ltr./min.   5,5 HP
<b>1310544</b>	Vacuum pump   85 ltr. tank   1500 ltr./min.   5,5 HP
<b>1310434</b>	Vacuum pump   65 ltr. tank   1500 ltr./min.   5,5 HP
<b>1310543</b>	Vacuum pump   85 ltr. tank   1250 ltr./min.   4 HP
<b>1310435</b>	Vacuum pump   65 ltr. tank   1250 ltr./min.   4 HP
<b>1310326</b>	Vacuum pump   65 ltr. tank   1000 ltr./min.   4 HP
<b>1310327</b>	Vacuum pump   65 ltr. tank   900 ltr./min.   3 HP
<b>1310328</b>	Vacuum pump   65 ltr. tank   750 ltr./min.   3 HP
<b>1310329</b>	Vacuum pump   65 ltr. tank   600 ltr./min.   2 HP
<b>1309580</b>	Vacuum pump   65 ltr. tank   500 ltr./min.   2 HP
<b>1309581</b>	Vacuum pump   28 ltr. tank   350 ltr./min.   1,5 HP

*Several parts available on request, also available without electro motor*



## Vacuum pump with console

<b>1310201</b>	Vacuum pump   console   2950 ltr./min.   7,5 HP
<b>1309573</b>	Vacuum pump   console   2300 ltr./min.   7,5 HP
<b>1309572</b>	Vacuum pump   console   2300 ltr./min.   5,5 HP
<b>1310132</b>	Vacuum pump   console   1500 ltr./min.   5,5 HP
<b>1309575</b>	Vacuum pump   console   1250 ltr./min.   4 HP
<b>1309577</b>	Vacuum pump   console   1000 ltr./min.   4 HP
<b>1309579</b>	Vacuum pump   console   750 ltr./min.   3 HP

*Several parts available on request*



## Vacuum pump only

<b>1310200</b>	Vacuum pump   only   3300 ltr.   including silencer and oil keeper
<b>1308411</b>	Vacuum pump   only   2200 ltr.   including silencer and oil keeper
<b>1309574</b>	Vacuum pump   only   1500 ltr.   including silencer and oil keeper
<b>1309576</b>	Vacuum pump   only   1000 ltr.   including silencer and oil keeper
<b>1309578</b>	Vacuum pump   only   750 ltr.   including silencer and oil keeper
<b>1310437</b>	Vacuum pump   only   500 ltr.   including silencer and oil keeper

*Several parts available on request, also available without silencer*



## Vacuum pump corr. DeLaval

<b>1309583</b>	Vacuum pump   1500 ltr.   corr. DeLaval VP76
<b>1309582</b>	Vacuum pump   1000 ltr.   corr. DeLaval VP76



## Vacuum pump corr. Fullwood

<b>1301695</b>	Vacuum pump   1100/1500 ltr./min.   4/5,5 HP   corr. Fullwood Q4
<b>1307171</b>	Vacuum pump   675/900 ltr./min.   3 HP   corr. Fullwood Q3
<i>Several parts available on request</i>	



## Vacuum pump with tank

<b>1307518</b>	Vacuum pump   22 ltr. tank   dry   electric motor 220V   250 ltr./min.   1 HP
----------------	---



## Mobile vacuum pump

<b>1310668</b>	Vacuum pump   mobile   22 ltr. tank   dry   electric motor 220V   200 ltr./min.
----------------	---



## Oil separator

<b>1310330</b>	Oil separator   for GPV 3300/2200
<b>1310331</b>	Oil separator   for GPV 1500/1000
<b>1310332</b>	Oil separator   for GPV 750/500



## Parts for GPV vacuum pump

<b>1310642</b>	Bearing   for GPV 2200/1500/1000/750/500
<b>1310643</b>	Oil seal   for GPV 2200/1500/1000/750/500



## Silencer

<b>1311339</b>	Silencer   2"   for GPV 3300/2200
<b>1311343</b>	Silencer   2"   for GPV 1600/1500/1000
<b>1311332</b>	Silencer   2"   for GPV 750/500



## Silencer corr. Fullwood

<b>1301676</b>	Silencer   2"   corr. Fulwood FR2/Q3/Q4
<b>1300758</b>	Silencer   1½"   corr. Fulwood FR2/Q3/Q4
<b>1307156</b>	Silencer   1¼"   corr. Fulwood FR2/Q3/Q4



## Oiler corr. DeLaval

<b>1307319</b>	Oiler   2-way   corr. DeLaval 958.550-90
<b>1307178</b>	Oiler   3-way   corr. DeLaval

*The separate spare parts are also available*



## Oil keeper universal

<b>1307167</b>	Oil keeper   universal
----------------	------------------------



## Oil keeper double

<b>1310610</b>	Oil keeper   double   2 x 600 ml   for GPV 2200/3300
----------------	--



## Oil keeper for GPV Vacuum pump

<b>1310614</b>	Oil keeper   for GPV 1500
----------------	---------------------------



## Vanes Kevlar

<b>1314062</b>	Vane   PV 3300   289 x 87 x 6 mm   Kevlar
<b>1309941</b>	Vane   PV 3000   215 x 68 x 8 mm   Kevlar
<b>1309940</b>	Vane   PV 2200   245 x 65 x 6 mm   Kevlar
<b>1309939</b>	Vane   PV 1500   164 x 65 x 6 mm   Kevlar   corr. DeLaval VP77
<b>1310311</b>	Vane   PV 1000   164 x 50 x 6 mm   Kevlar   corr. DeLaval VP76
<b>1309938</b>	Vane   PV 750   82 x 65 x 6 mm   Kevlar
<b>1310309</b>	Vane   PV 500   82 x 50 x 6 mm   Kevlar
<b>1310308</b>	Vane   PV 350   120 x 45 x 5 mm   Kevlar



## Vanes corr. DeLaval Celeron

<b>1300774</b>	Vane		203 x 76 x 6,2 mm		corr. DeLaval VP78
<b>1300773</b>	Vane		199,9 x 60,3 x 5,3 mm		corr. DeLaval VP77
<b>1300772</b>	Vane		152,3 x 48,4 x 4,6 mm		corr. DeLaval VP76 and Manus PV1000
<b>1300770</b>	Vane		120 x 40 x 4,6 mm		corr. DeLaval VP18
<b>1300771</b>	Vane		82,5 x 48,8 x 4,6 mm		corr. DeLaval VP74, VP76 and Manus PV500



## Vanes corr. Fullwood Celeron

<b>1307176</b>	Vane		279,3 x 64 x 4,7 mm		only fits ref. 1301695   corr. Fullwood Q4
<b>1300777</b>	Vane		278 x 44,5 x 4,3 mm		corr. Fullwood FR4
<b>1300776</b>	Vane		181 x 44,5 x 4,5 mm		corr. Fullwood FR3
<b>1307173</b>	Vane		179,7 x 64 x 4,7 mm		corr. Fullwood Q3
<b>1307159</b>	Vane		119,7 x 64 x 4,7 mm		corr. Fullwood FR2
<b>1300775</b>	Vane		117,5 x 44,5 x 4,5 mm		corr. Fullwood FR2



## Vanes corr. SAC Celeron

<b>1300789</b>	Vane		152,4 x 51,1 x 4,7 mm		corr. SAC 1000 ltr.
<b>1300790</b>	Vane		152,3 x 51,1 x 4,9 mm		corr. SAC 1350 ltr.
<b>1300788</b>	Vane		82,4 x 51,1 x 4,7 mm		corr. SAC 600 ltr.



## Vanes corr. Westfalia Celeron

<b>1300796</b>	Vane		200 x 33 x 4,9 mm		corr. Westfalia RPS20
<b>1300795</b>	Vane		150 x 33 x 4,9 mm		corr. Westfalia RPS15
<b>1300794</b>	Vane		100 x 33 x 4,9 mm		corr. Westfalia RPS10
<b>1300793</b>	Vane		70 x 33 x 4,9 mm		corr. Westfalia RPS 7
<b>1300792</b>	Vane		50 x 33 x 4,9 mm		corr. Westfalia RPS 5





## Vanes

<b>1310447</b>	Vane   205 x 65 x 8 mm
<b>1310446</b>	Vane   205 x 55 x 8 mm
<b>1300780</b>	Vane   168,3 x 31,6 x 4,5 mm   corr. Gascoigne Melotte C-pump
<b>1300760</b>	Vane   152,4 x 50,8 x 5 mm   corr. Varie
<b>1300759</b>	Vane   82,5 x 50,8 x 5 mm   corr. Varie



## Vanes graphite

<b>1307528</b>	Vane   graphite   70 x 45 x 4,8 mm
<b>1307529</b>	Vane   graphite   65 x 45 x 4,8 mm   fitt. mini milkers type Reci Prof
<b>1310278</b>	Vane   graphite   70 x 42,9 x 5 mm   for Moby mini milker

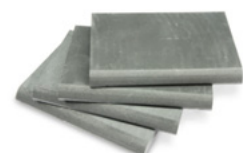

## Vacuum regulator corr. Servac

<b>1300900</b>	Vacuum regulator   1"   3500 ltr./min.   corr. Servac 45263a
<b>1300931</b>	Filter housing   corr. Servac 45271
<b>1310346</b>	Repair kit   corr. Servac 45277
<b>1300930</b>	Filter   corr. Servac 45268
<b>1300997</b>	Set of filter housing and filter   corr. Servac 45234
<b>1300927</b>	Filter   corr. Servac
<b>1300928</b>	Inner filter   corr. Servac 45259
<b>1301717</b>	Diaphragm   big   corr. Servac 45227
<b>1301939</b>	Diaphragm   small   corr. Servac
<b>1300911</b>	O-ring   small   corr. Servac 007631
<b>1300921</b>	O-ring   big   corr. Servac

*Several parts available on request*



## Vacuum regulator 7000 ltr. corr. Servac

<b>1311020</b>	Vacuum regulator   1"   7000 ltr./min.   corr. Servac
<b>1311021</b>	Slave   1"   for 7000 ltr./min.   corr. Servac
<b>1300931</b>	Filter housing   corr. Servac 45271
<b>1310346</b>	Repair kit   corr. Servac 45277
<b>1300930</b>	Filter   corr. Servac 45268
<b>1300927</b>	Filter   corr. Servac 45234
<b>1301717</b>	Diaphragm   big   corr. Servac 45227
<b>1301939</b>	Diaphragm   small   corr. Servac
<i>Several parts available on request</i>	

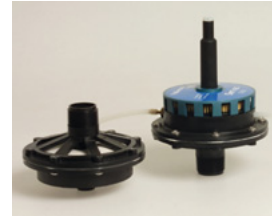

## Vacuum regulator corr. Gascoigne Melotte

<b>1300901</b>	Vacuum regulator   1"   3500 ltr./min.   orange cover   corr. Gascoigne Melotte D700150
<b>1300931</b>	Filter housing   corr. Servac/Gascoigne Melotte 45271
<b>1310346</b>	Repair kit   corr. Servac/Gascoigne Melotte 045277
<b>1300930</b>	Filter   corr. Servac/Gascoigne Melotte 45268
<b>1300997</b>	Set of filter housing and filter   corr. Servac/Gascoigne Melotte
<b>1300927</b>	Filter   corr. Servac/Gascoigne Melotte 45234
<b>1300928</b>	Inner filter   corr. Servac/Gascoigne Melotte 45259
<b>1301717</b>	Diaphragm   big   corr. Servac/Gascoigne Melotte 45227
<b>1301939</b>	Diaphragm   small   corr. Servac/Gascoigne Melotte
<b>1300911</b>	O-ring   small   corr. Servac/Gascoigne Melotte 007617
<b>1300921</b>	O-ring   big   corr. Servac/Gascoigne Melotte 007631
<b>1300903</b>	Orange cover   corr. Gascoigne Melotte 1795600
<i>Several parts available on request</i>	



## Vacuum regulator corr. M-Tec

<b>1300999</b>	Vacuum regulator   1"   3500 ltr./min.   M-Tec
<b>1300931</b>	Filter housing   corr. Servac/Gascoigne Melotte 45271
<b>1310346</b>	Repair kit   corr. Servac/Gascoigne Melotte 45277
<b>1300930</b>	Filter   corr. Servac/Gascoigne Melotte 45268
<b>1300997</b>	Set of filter housing and filter   corr. Servac/Gascoigne Melotte
<b>1300927</b>	Filter   corr. Servac/Gascoigne Melotte 45234
<b>1300928</b>	Inner filter   corr. Servac/Gascoigne Melotte 45259
<b>1301717</b>	Diaphragm   big   corr. Servac/Gascoigne Melotte 45227
<b>1301939</b>	Diaphragm   small   corr. Servac/Gascoigne Melotte
<b>1300911</b>	O-ring   small   corr. Servac/Gascoigne Melotte 007617
<b>1300921</b>	O-ring   big   corr. Servac/Gascoigne Melotte 007631
<b>1300933</b>	Blue cover   M-Tec

*Several parts available on request*



## Vacuum regulator

<b>1300951</b>	Vacuum regulator   1"   500-3500 ltr./min.   30-60 kpa
<b>1300935</b>	Vacuum regulator   1"   20-400 ltr./min.   30-60 kpa

*Several parts available on request*

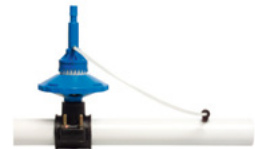

## Vacuum regulator corr. Westfalia Vacurex

<b>1300980</b>	Vacuum regulator   1"   3000 ltr./min.   corr. Westfalia
----------------	--

*Several parts available on request*



## Vacuum-spring regulator plastic

<b>1301004</b>	Vacuum-spring regulator   plastic   3/4"
----------------	--



## Vacuum-spring regulator brass

<b>1307341</b>	Vacuum-spring regulator   with large button   brass   1"
----------------	--

## Vacuum-spring regulator brass

**1307342** Vacuum-spring regulator | brass | ¾"



## Vacuum regulator Sentinel Mark II

**1307335** Vacuum regulator | Sentinel Mark II | 4000 ltr./min.

**1307340** Replacement kit

**1307336** Seal

**1307339** Upper filter

*Several parts available on request*



## Vacuum regulator Sentinel Mark

**1310533** Vacuum regulator | Sentinel Mark | 500-14000 ltr./min.



## Filter corr. Westfalia Vacurex

**1340482** Filter | corr. Westfalia Vacurex



## VRS sponge filter corr. DeLaval

**1311212** VRS sponge filter | corr. DeLaval 967.989-02

## VRS spring corr. DeLaval

**1311213** VRS spring | corr. DeLaval 964.322-01



## Parts corr. Westfalia / Surge Commander

<b>1314170</b>	Filter   set of 6 pieces   corr. Westfalia-Surge Commander 7750-0213-851
<b>1314172</b>	Filter   corr. Westfalia-Surge Commander 7750-0213-854
<b>1314176</b>	Diaphragm   upper   corr. Westfalia-Surge Commander 7750-0013-858
<b>1314174</b>	Diaphragm   bottom   corr. Westfalia-Surge Commander 7750-0013-853
<b>1314184</b>	Repair kit   set with 4 pieces   corr. Westfalia-Surge Commander 7750-013-889
<b>1314182</b>	Filters   set of 2 pieces   corr. Westfalia-Surge Commander 77750-9905-200



## Filters Surge

<b>1314188</b>	Filters   set of 5 pieces   corr. Surge Equalizer 7750-0213-350
<b>1314186</b>	Filter   Ø 340 x 12 mm   corr. Surge ALAMO 7750-0214-865



## Vacuum meter Ø 63 mm

<b>1301010</b>	Vacuum meter   dry   black   Ø 63 mm   ¼" BSP connection
----------------	--



## Vacuum meter Ø 100 mm

<b>1301012</b>	Vacuum meter   dry   black   Ø 100 mm   ½" BSP connection
----------------	---



## Vacuum meter Ø 100 mm S/S

<b>1301013</b>	Vacuum meter   dry   S/S   Ø 100 mm   ½" BSP connection
----------------	---



## Vacuum meter Ø 63 mm back connection

<b>1301017</b>	Vacuum meter   dry   black   Ø 63 mm   ¼" BSP back connection
----------------	---



## Vacuum meter Ø 63 mm glycerin

**1301011** Vacuum meter | glycerin | S/S | Ø 63 mm | ¼" BSP connection



## Vacuum meter Ø 100 mm glycerin

**1301015** Vacuum meter | glycerin | S/S | Ø 100 mm | ½" BSP connection



## Vacuum meter Ø 160 mm glycerin

**1330108** Vacuum meter | glycerin | S/S | Ø 160 mm | ½" BSP connection



## Vacuum meter S/S Ø 80 mm adjustable

**1311033** Vacuum meter | dry | S/S | adjustable | Ø 80 mm | ½" BSP connection



## Vacuum meter Ø 100 mm adjustable

**1311030** Vacuum meter | dry | black | adjustable | Ø 100 mm | ½" BSP connection



## Vacuum meter S/S Ø 100 mm adjustable

**1311040** Vacuum meter | dry | S/S | adjustable | Ø 100 mm | ½" BSP connection



## Vacuum tester

**1301931** Digital vacuum tester | portable | DVPM-01

**1301932** Bag | leather



## Vacuum valve right-angled

<b>1300880</b>	Vacuum valve   right-angled   90°   ½" BSP connection
<b>1300879</b>	Vacuum valve   right-angled   90°   ¾" BSP connection



## Vacuum valve straight

<b>1300881</b>	Vacuum valve   straight   ½" BSP connection
----------------	---



## Vacuum clamp valve right-angled 90°

<b>1300882</b>	Vacuum clamp valve   right-angled   90°   ¾"-1"   including rubber gasket
<b>1300883</b>	Vacuum clamp valve   right-angled   90°   1¼"-1½"   including rubber gasket



## Vacuum clamp valve

<b>1300884</b>	Vacuum clamp valve   1¼"-1½"   ½" BSP connection   including rubber gasket
<b>1300885</b>	Vacuum clamp valve   2"   ½" BSP connection   including rubber gasket



## Vacuum valve

<b>1300886</b>	Vacuum valve   with pipe clamp   1¼"-1½"   including gasket
<b>1300887</b>	Vacuum valve   with pipe clamp   ¾"-1"   including gasket



## Connecting tube vacuum valve

<b>1300889</b>	Vacuum valve   connecting tube   complete
<b>1310836</b>	Connecting tube
<b>1300891</b>	Spring
<b>1300890</b>	Gasket   24 x 12 x 4 mm



## Gasket for vacuum valves

<b>1300888</b>	Gasket   for several vacuum valves   20 x 12,5 x 3,75 mm
----------------	--

## Vacuum valve

<b>0100856</b>	Vacuum valve   PVC   50 mm
<b>0100857</b>	Vacuum valve   PVC   63 mm
<b>0100885</b>	Vacuum valve   PVC   75 mm
<b>1307199</b>	Vacuum valve   PVC   90 mm
<b>0100859</b>	Vacuum valve   PVC   110 mm



## Vacuum valve white Imperial

<b>1301965</b>	Vacuum valve   PVC   white Imperial   2" (+/- 60,3 mm)
<b>1301966</b>	Vacuum valve   PVC   white Imperial   3" (+/- 88,5 mm)



## Vacuum balance tank green/blue

<b>1309549</b>	Vacuum balance tank   vertical   PVC   blue   33 ltr.   2 x 63 mm
<b>1309610</b>	Vacuum balance tank   vertical   PVC   green   33 ltr.   2 x 63 mm
<b>1310347</b>	Vacuum balance tank   vertical   PVC   blue   33 ltr.   2 x 90 mm
<b>1310348</b>	Vacuum balance tank   vertical   PVC   green   33 ltr.   2 x 90 mm
<b>1310484</b>	Lid   complete   2 x 63 mm
<b>1310481</b>	Lid   complete   2 x 90 mm
<b>1310425</b>	Gasket
<b>1310514</b>	Drain valve
<b>1310516</b>	Valve
<b>1310515</b>	Protector   for valve
<b>1310517</b>	Gasket   for valve



## Vacuum balance tank white

<b>1307195</b>	Vacuum balance tank   horizontal   PVC   white   110 ltr.
<b>1307196</b>	Vacuum balance tank   vertical   PVC   white   110 ltr.



## Outlet for vacuum balance tank

<b>1307192</b>	Outlet   with valve   1"   PVC   white
<b>1307193</b>	Outlet   with valve   1¼"   PVC   white
<b>1309913</b>	Outlet   with valve   1½"   PVC   white
<b>1307194</b>	Valve   rubber





## Moisture trap

<b>1308689</b>	Moisture trap   without lid   corr. DeLaval 959.949-82 VPU 74/76
<b>1309919</b>	Lid   3 x Ø 75 mm   corr. DeLaval VPU 74/76
<b>1308378</b>	Joint   corr. DeLaval 951783



## Airflow meter

<b>1307856</b>	Airflow meter   up to 3000 ltr./min.   with test equipment
----------------	--



## Airflow meter AFM

<b>1311215</b>	Airflow meter   AFM   up to 3000 ltr./min.
<b>1311234</b>	Scale   set
	<i>Several parts available on request</i>



## Drain valve corr. Dairymaster

<b>1316315</b>	Drain valve   corr. Dairymaster JT302
----------------	---------------------------------------



## Air filter corr. Dairymaster

<b>1316285</b>	Air filter   corr. Dairymaster RE200
----------------	--------------------------------------



## Gasket corr. Gascoigne Melotte

<b>1301396</b>	Gasket   for vacuumtank   316 x 292 x 8 mm   green   corr. Gascoigne Melotte D242.030
----------------	---

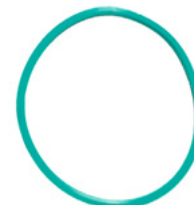



Chapter 6

# TAKE-OFF

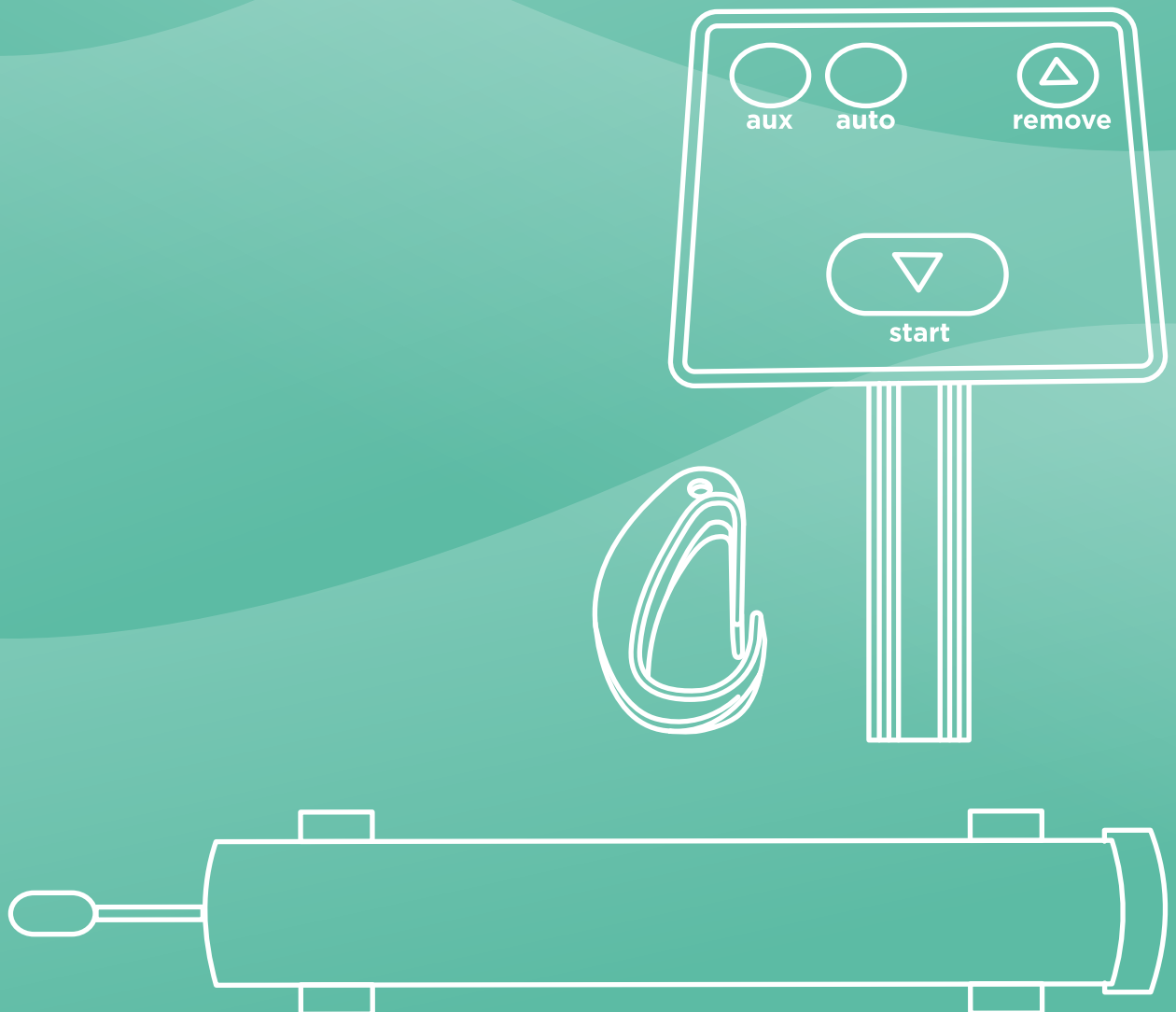

## Chapter 6 Take-off

Take-off cylinder	P112
Repair kit corr. Surge EAS	P112
Control unit corr. Westfalia	P112
PCB controller universal	P112
Board corr. DeLaval ACR 5000	P112
Keypad corr. DeLaval	P112
Reed sensor corr. DeLaval	P112
Diaphragm corr. DeLaval HFC	P113
Parts corr. DeLaval Duovac	P113
Parts corr. DeLaval ATOP	P113
Milk flow indicator	P113
Snap hook S/S	P114
Snap hook plastic	P114
Security clip plastic	P114
Take off cord	P114
Bracket S/S	P114
Repair kit corr. Gascoigne Melotte DV1	P114

## Take-off cylinder

<b>1309860</b>	Take-off cylinder   S/S   920 x 51 mm
<b>1300673</b>	Take-off cylinder   S/S   695 x 76 mm
<b>1300674</b>	Repair kit   for take-off cylinder 695 x 76 mm
<b>1307703</b>	Bracket   S/S   for take-off cylinder 695 x 76 mm



## Repair kit corr. Surge EAS

<b>1330110</b>	Repair kit   for take-off cylinder   corr. Surge EAS <i>Spare Parts are also separate available</i>
----------------	--



## Control unit corr. Westfalia

<b>1316190</b>	Control unit   MAG   corr. Westfalia 7053.2678.039
----------------	--

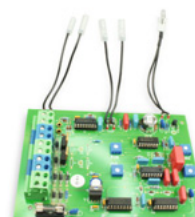

## PCB controller universal

<b>1330053</b>	PCB controller   for automatic take-off   pulsationstop   12/24V AC or DC   adjustable milking time of 2-4-6-8-10-12 sec.
----------------	---



## Board corr. DeLaval ACR 5000

<b>1330140</b>	Board   old model   corr. DeLaval ACR 5000 MK2 997.799-82, 986.560-80, 999.266-82
<b>1330142</b>	Board   new model   corr. DeLaval ACR 5000 MK3 918.907-02, 918.905-30, 918.905-80



## Keypad corr. DeLaval

<b>1330058</b>	Keypad   corr. DeLaval ACR 5000 987.718-01, 987.718-02
----------------	--



## Reed sensor corr. DeLaval

<b>1309788</b>	Reed sensor   3 mtr. cable   corr. DeLaval 984.482-01
<b>1309799</b>	Reed sensor   20 mtr. cable   corr. DeLaval 984.482-03
<b>1310704</b>	Reed sensor   5 mtr. with silicone cable   corr. DeLaval 7349713-30



## Diaphragm corr. DeLaval HFC

**1316237** Diaphragm | corr. DeLaval HFC 858509-01-01



## Parts corr. DeLaval Duovac

**1311613** Container | pneumatic | corr. DeLaval Duovac 967.485-03

**1311614** Container | electric | corr. DeLaval ATOP 967.485-01

**1311615** Gasket | corr. DeLaval Duovac 960.454-07 and ATOP 952.370-07

**1311657** Diaphragm | for container | corr. DeLaval Duovac 958.689-01

**1311616** Lid | straight | corr. DeLaval Duovac 985.484-01

**1311617** Lid | right-angled | corr. DeLaval Duovac 969.473-01

**1311618** Top lid | with exit | corr. DeLaval Duovac and ATOP 989.473-02

**1311608** Float | pneumatic | corr. DeLaval Duovac 9881114-80

**1311619** Drain pipe | 200 ml. | corr. DeLaval Duovac 960.454-07

**1311610** Drain pipe | 300 ml. | corr. DeLaval Duovac 960.454-08

**1316235** Holder | pneumatic | corr. DeLaval Duovac 968.538-03

**1316496** Bellow | small | corr. DeLaval Duovac 965.488-01

**1316495** Bellow | big | corr. DeLaval Duovac 968.434-02

**1309770** Diaphragm | corr. DeLaval Duovac 965.425-80

**1315049** Diaphragm | original | DeLaval Duovac 965.425-80

**1311662** Float | electric | original | DeLaval Duovac 987155-80



## Parts corr. DeLaval ATOP

**1330101** Piston sleeve | corr. DeLaval ATOP 983.461-01

**1330103** Piston | corr. DeLaval ATOP 983.457-01

**1330105** O-ring | Ø 84 mm | corr. DeLaval 260.104-77



## Milk flow indicator

**1301205** Milk flow indicator | for ACR | 3 meter cable

**1307361** Lid | separate

**1307362** Diaphragm | black silicone



## Snap hook S/S

<b>1301825</b>	Snap hook   S/S   5 x 50 mm
<b>1301672</b>	Snap hook   S/S   6 x 60 mm
<b>1301942</b>	Snap hook   S/S   7 x 70 mm
<b>1301943</b>	Snap hook   S/S   5 x 50 mm   with eye



## Snap hook plastic

<b>1311291</b>	Snap hook   plastic   white   corr. DeLaval 966.648-01
<b>1330095</b>	Snap hook   plastic   black   corr. DeLaval 915.564-01



## Security clip plastic

<b>1330097</b>	Security clip   plastic
----------------	-------------------------



## Take off cord

<b>1330099</b>	Take off cord   Ø 5 mm   black   200 mtr./coil   corr. DeLaval
----------------	--



## Bracket S/S

<b>1330106</b>	Bracket   S/S   Ø 90 mm   for take off cylinder   corr. DeLaval
----------------	---



## Repair kit corr. Gascoigne Melotte DV1

<b>1330078</b>	Repair kit   corr. Gascoigne Melotte DV1 D225.661
<b>1309868</b>	Diaphragm   corr. Gascoigne Melotte D381.667



Chapter 7

# MILKPUMPS AND ACCESSORIES

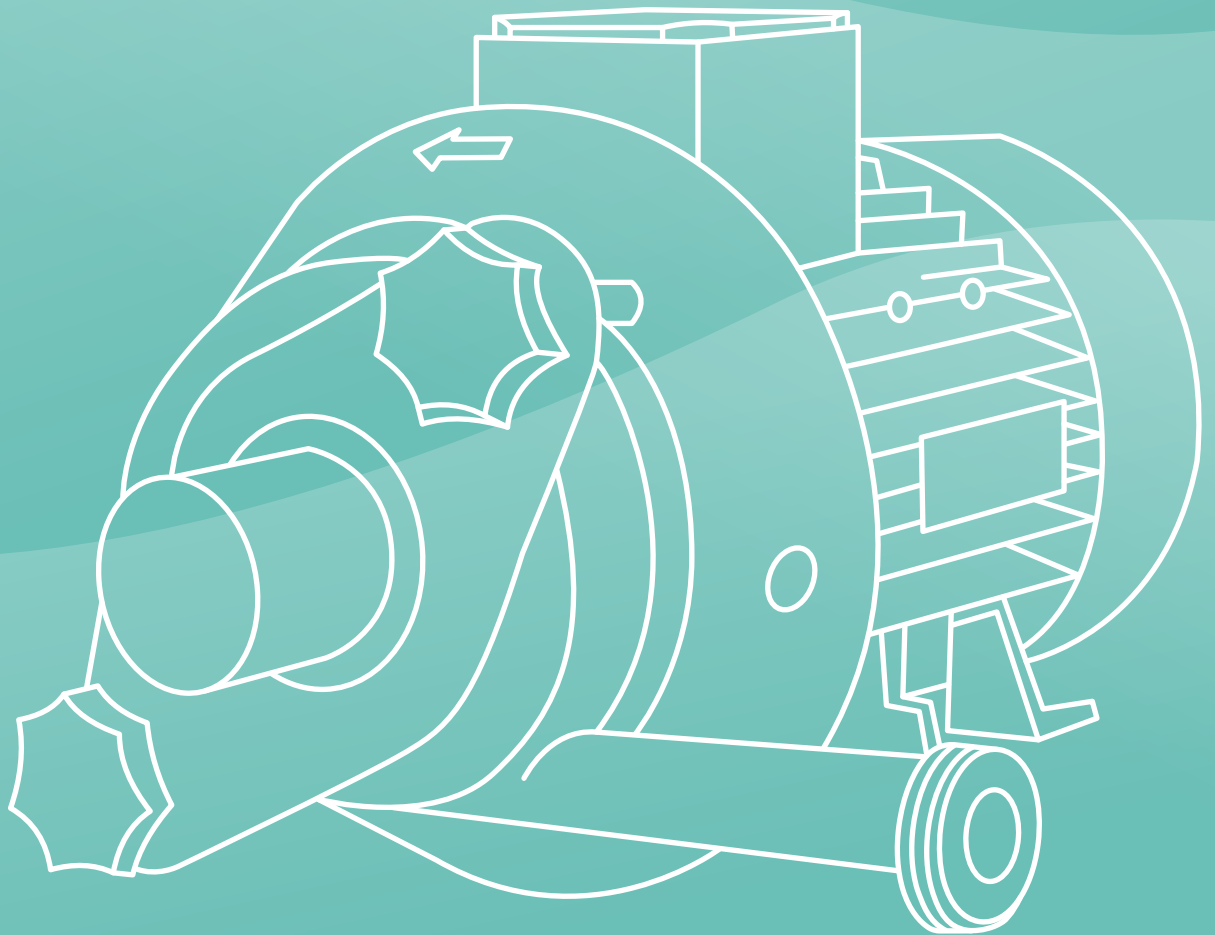



## Chapter 7 Milk pumps and accessories

Milk pump corr. DeLaval GM-2	P117
Repair kit corr. DeLaval GM-2   6-pieces	P117
Repair kit corr. DeLaval GM-2   4-pieces	P117
Parts corr. DeLaval GM-2	P117
Electric motor corr. DeLaval	P117
Parts corr. DeLaval PC900	P118
Milk pump corr. DeLaval FMP 110	P118
Repair kit corr. DeLaval FMP 110	P118
Parts corr. DeLaval FMP 110	P118
Milk pump corr. DeLaval FMP 55	P119
Repair kit corr. DeLaval FMP 55	P119
Parts corr. DeLaval FMP 55	P119
Non-retun valve corr. DeLaval	P119
Milk pump 0,55 kW type 4100	P120
Parts for Milk pump 0,55 kW	P120
Milk pump 0,75 kW type 4600	P120
Parts for milk pump 0,75 kW	P121
Milk pump 1,1 kW	P121
Parts for milk pump 1,1 kW	P122
Milk pump corr. FP 66	P122
Seal kit corr. Fullwood/Westfalia	P122
O-ring pump house corr. Fullwood/Westfalia	P122
Repair kit corr. Dairymaster	P123
Seal kit corr. Dairymaster	P123
Non-return valve corr. Dairymaster	P123
Ring corr. Dairymaster	P123
Graphite seal corr. Gascoigne Melotte	P123
Impeller corr. Gascoigne Melotte	P123
Parts corr. Boumatic and Gascoigne Melotte	P123
O-ring corr. Gascoigne Melotte	P123
Non-return valve corr. Gascoigne Melotte	P124
Milk pump corr. Westfalia	P124
Impeller corr. Westfalia	P124
Gasket corr. Westfalia	P124
Non-return valve corr. Westfalia	P124
Seal kit corr. Westfalia new model	P124
Seal kit corr. Westfalia	P124
Graphite seal milk pump corr. Surge	P125

Non-return valve corr. Westfalia	P125
Non-return valve corr. Strangko	P125
Non-return valve corr. Miele	P125
Non-return valve corr. Lely	P125
S/S outlet	P125
Drain valve	P125
Control unit Miele milk pump	P126
Level control	P126

## Milk pump corr. DeLaval GM-2

**1330190** Milk pump | 0,55 kW | 380V | corr. DeLaval GM-2

## Repair kit corr. DeLaval GM-2 | 6-pieces

**1316335** Repair kit | corr. DeLaval GM-2 967.519-80

## Repair kit corr. DeLaval GM-2 | 4-pieces

**1316330** Repair kit | 4-pieces | corr. DeLaval GM-2 3145600771

## Parts corr. DeLaval GM-2

**1301379** Impeller | corr. DeLaval GM-2 3145600251

**1301381** Gasket | corr. DeLaval GM-2 314701211

**1301382** Graphite seal | corr. DeLaval GM-2 3143702111

**1301383** O-ring | corr. DeLaval and Manus 3143901681

**1301384** O-ring | rubber | Ø 110 mm | corr. DeLaval 22341275

**1316334** S/S counter face | corr. DeLaval GM-2 3144501191

**1300752** Non-return valve | rubber | Ø 42 mm | corr. DeLaval GM-2 951.589-01

**1300753** Non-return valve | rubber | Ø 44 mm | corr. DeLaval GM-2

*Several parts suitable for the milk pump DeLaval GM-2 available on request*

## Electric motor corr. DeLaval

**1330192** Electric motor | 220V | corr. DeLaval PC900



## Parts corr. DeLaval PC900

<b>1301376</b>	Impeller   plastic   corr. DeLaval PC900 958.048-01
<b>1301377</b>	Gasket   for shaft   corr. DeLaval PC900 960.560-01
<b>1301378</b>	Gasket   rubber   corr. DeLaval PC900 958.294-01
<b>1316210</b>	Joint   for glass jar   corr. DeLaval PC900 958.052-01
<b>1316485</b>	Backplate   corr. DeLaval PC900 987.023-80
<b>1316490</b>	Seal   rubber   corr. DeLaval PC900 959.084-01

*Several parts suitable for the milk pump DeLaval PC900 available on request*



## Milk pump corr. DeLaval FMP 110

<b>1330170</b>	Milk pump   1,1 kW   380V   outlet left 2"   corr. DeLaval FMP 110
<b>1330180</b>	Milk pump   1,1 kW   380V   outlet right 2"   corr. DeLaval FMP 110



## Repair kit corr. DeLaval FMP 110

<b>1330173</b>	Repair kit   corr. DeLaval FMP 110
<b>1330177</b>	Graphite seal   corr. DeLaval FMP 110 996.836-01
<b>1330179</b>	O-ring   corr. DeLaval FMP 110

*The separate spare parts are also available*



## Parts corr. DeLaval FMP 110

<b>1330185</b>	Electric motor   1,1 kW   corr. DeLaval FMP 110 995.791-80
<b>1330178</b>	Flange   corr. DeLaval FMP 110 996.931-80
<b>1330174</b>	Backplate   corr. DeLaval FMP 110 996.830-01
<b>1330175</b>	Backplate   heavy model   corr. DeLaval FMP 110
<b>1330176</b>	Impeller   S/S   corr. DeLaval FMP 110 905.821-80
<b>1330172</b>	Pump housing   left   corr. DeLaval FMP 110
<b>1330182</b>	Pump housing   right   corr. DeLaval FMP 110
<b>1311680</b>	Seal   for Pump housing   Ø 140 mm   corr. DeLaval FMP 55 and 110 995.443-01
<b>1330177</b>	Graphite seal   corr. DeLaval FMP 110 996.836-01
<b>1330179</b>	O-ring   corr. DeLaval FMP 110
<b>1330164</b>	Holder set   complete   corr. DeLaval FMP 55 and 110 995.787-80
<b>1316232</b>	Drain nut   plastic   corr. DeLaval 999.585-01
<b>1311650</b>	Non-return valve   S/S   Ø 50 mm   corr. DeLaval FMP 55 and 110 989.765-80



## Milk pump corr. DeLaval FMP 55

<b>1330150</b>	Milk pump   0,55 kW   380V   outlet left 2"   corr. DeLaval FMP 55
<b>1330160</b>	Milk pump   0,55 kW   380V   outlet right 2"   corr. DeLaval FMP 55



## Repair kit corr. DeLaval FMP 55

<b>1316340</b>	Repair kit   6-pieces   corr. DeLaval FMP 55
<b>1301382</b>	Graphite seal   corr. DeLaval 314701211
<b>1301383</b>	O-ring   corr. DeLaval and Manus 3143901681
<b>1316342</b>	Seegerring   corr. DeLaval FMP 55
<b>1301386</b>	Washer   S/S   Ø 30 mm   corr. DeLaval 0010412500
<b>1301387</b>	Washer   S/S   Ø 45 mm   corr. DeLaval 3143700381
<b>1301385</b>	Spring   S/S   corr. DeLaval 0010415400



## Parts corr. DeLaval FMP 55

<b>1330165</b>	Electric motor   0,55 kW   corr. DeLaval FMP 55 995.791-81
<b>1330158</b>	Flange   corr. DeLaval FMP 55 995.449-80
<b>1330154</b>	Backplate   corr. DeLaval FMP 55 967.528-80
<b>1330156</b>	Impeller   S/S   corr. DeLaval FMP 55 906.850-80
<b>1311295</b>	Impeller   plastic   corr. DeLaval FMP 55 995.448-01
<b>1330152</b>	Pump housing   left   corr. DeLaval FMP 55
<b>1330162</b>	Pump housing   right   corr. DeLaval FMP 55
<b>1311680</b>	Seal   for Pump housing   Ø 140 mm   corr. DeLaval FMP 55 and 110 995.443-01
<b>1330164</b>	Holder set   complete   corr. DeLaval FMP 55 and 110 995.787-80
<b>1316232</b>	Drain nut   plastic   corr. DeLaval 999.585-01
<b>1311650</b>	Non-return valve   S/S   Ø 50 mm   corr. DeLaval FMP 55 and 110 989.765-80



## Non-return valve corr. DeLaval

<b>1307037</b>	Non-return valve   rubber   Ø 50 mm   corr. DeLaval 967.164-01
<b>1308212</b>	Non-return valve   rubber   Ø 40 mm   corr. DeLaval 957.859-01
<b>1300752</b>	Non-return valve   rubber   Ø 42 mm   corr. DeLaval GM-2 951.589-01



## Milk pump 0,55 kW type 4100

<b>1300697</b>	Milk pump   0,55 kW   3 phase   230/400V   IP 55   small
<b>1300683</b>	Milk pump   0,55 kW   3 phase   230/400V   IP 55   small   with rinse pipe
<b>1300694</b>	Milk pump   0,55 kW   1 phase   230V   IP55   small
<b>1300681</b>	Milk pump   0,55 kW   1 phase   230V   IP55   small   with rinse pipe



## Parts for Milk pump 0,55 kW

<b>1300684</b>	Motor   0,55 kW   3 phase   230/400V   IP 55   small
<b>1300682</b>	Motor   0,55 kW   1 phase   230V   IP 55   small
<b>1300696</b>	Pump set   for small Milk pump without rinse pipe
<b>1300714</b>	Flange
<b>1300716</b>	Backplate
<b>1300724</b>	Impeller   S/S   small
<b>1300733</b>	Impeller   S/S   with 8 blades
<b>1300723</b>	Pump housing   without rinse pipe
<b>1300691</b>	Pump housing   with rinse pipe
<b>1300720</b>	Clamping plate
<b>1300719</b>	Seal Pump housing   rubber
<b>1300717</b>	Seal   for spring for backplate
<b>1300718</b>	Seal   ceramic   for rotor
<b>1310736</b>	Assembling device for seal
<b>1300722</b>	Star button screw   M10
<b>1300751</b>	Non-return valve   rubber   Ø 40 mm   corr. Fullwood 35227
<b>1307821</b>	Cover   S/S   for milk pump 1300683
<b>1307823</b>	Cover   S/S   for milk pump 1300681
<b>1301285</b>	Base plate   S/S



## Milk pump 0,75 kW type 4600

<b>1300703</b>	Milk pump   0,75 kW   3 phase   230/400V   IP 55   large
<b>1300709</b>	Milk pump   0,75 kW   3 phase   230/400V   IP 55   large   with rinse pipe
<b>1300706</b>	Milk pump   0,75 kW   1 phase   230V   IP 55   large
<b>1300689</b>	Milk pump   0,75 kW   1 phase   230V   IP 55   large   with rinse pipe



## Parts for milk pump 0,75 kW

<b>1300704</b>	Motor   0,75 kW   3 phase   230/400V   IP55   large
<b>1300688</b>	Motor   0,75 kW   1 phase   230V   4.6A   large
<b>1300707</b>	Motor   0,75 kW   3 phase   230/400V   IE3   large   lower power consumption
<b>1300702</b>	Pump set   for large milk pump without rinse pipe
<b>1300729</b>	Flange
<b>1300731</b>	Backplate
<b>1300732</b>	Impeller   S/S
<b>1307735</b>	Pump housing   without rinse pipe
<b>1300692</b>	Pump housing   with rinse pipe
<b>1300736</b>	Clamping plate
<b>1300735</b>	Seal Pump housing   rubber
<b>1300717</b>	Seal   for spring for backplate
<b>1300718</b>	Seal   ceramic   for rotor
<b>1310736</b>	Assembling device for seal
<b>1300722</b>	Star button screw   M10
<b>1300751</b>	Non-return valve   rubber   Ø 40 mm   corr. Fullwood 35227
<b>1307824</b>	Cover   S/S   for milk pump 1300689
<b>1301285</b>	Base plate   S/S



## Milk pump 1,1 kW

<b>1300700</b>	Milk pump   1,1 kW   3 phase   230/400V   IP 55   large
<b>1300685</b>	Milk pump   1,1 kW   3 phase   230/400V   IP 55   large   with rinse pipe



## Parts for milk pump 1,1 kW

<b>1300686</b>	Motor   1,1 kW   3 phase   230/400V   IP55   large
<b>1300687</b>	Motor   1,1 kW   3 phase   230/400V   IP 55 (IE3)   large   lower power consumption
<b>1300702</b>	Pump set   for large milk pump without rinse pipe
<b>1300729</b>	Flange
<b>1300731</b>	Backplate
<b>1300732</b>	Impeller
<b>1307735</b>	Pump housing   without rinse pipe
<b>1300692</b>	Pump housing   with rinse pipe
<b>1300736</b>	Clamping plate
<b>1300735</b>	Seal pump housing   rubber
<b>1300717</b>	Seal   for spring for backplate
<b>1300718</b>	Seal   ceramic   for rotor
<b>1310736</b>	Assembling device for seal
<b>1300722</b>	Star button screw   M10
<b>1300751</b>	Non-return valve   rubber   Ø 40 mm   corr. Fullwood 35227
<b>1307822</b>	Cover   S/S   for milk pump 1300685
<b>1301285</b>	Base plate   S/S



## Milk pump corr. FP 66

<b>1330135</b>	Milk pump   1,5 kW   3 phase   380V   corr. FP 66 Westfalia and Fullwood
<b>1330125</b>	Milk pump   1,1 kW   3 phase   380V   corr. FP 66 Westfalia and Fullwood
<b>1330130</b>	Milk pump   1,5 kW   1 phase   220V   corr. FP 66 Westfalia and Fullwood
<b>1330120</b>	Milk pump   1,1 kW   1 phase   220V   corr. FP 66 Westfalia and Fullwood



## Seal kit corr. Fullwood/Westfalia

<b>1330137</b>	Seal kit   for milk pump   corr. Fullwood FP66 227728
----------------	---



## O-ring pump house corr. Fullwood/Westfalia

<b>1330139</b>	O-ring   for pump housing   corr. Fullwood FP66 45076
----------------	---





## Repair kit corr. Dairymaster

<b>1316260</b>	Repair kit   corr. Dairymaster CP213
<b>1316265</b>	Gasket for lid   corr. Dairymaster CP204



## Seal kit corr. Dairymaster

<b>1316270</b>	Seal kit   corr. Dairymaster CP201
----------------	------------------------------------



## Non-return valve corr. Dairymaster

<b>1316275</b>	Non-return valve   corr. Dairymaster CP211
----------------	--



## Ring corr. Dairymaster

<b>1316280</b>	Ring   3-way valve   corr. Dairymaster RJ14
----------------	---



## Graphite seal corr. Gascoigne Melotte

<b>1301390</b>	Graphite seal   corr. Gascoigne Melotte T225.001
----------------	--



## Impeller corr. Gascoigne Melotte

<b>1301391</b>	Impeller   plastic   corr. Gascoigne Melotte D255096 MelotteT428.201
<b>1307039</b>	Ceramic seal   corr. Gascoigne Melotte D255096
<b>1307038</b>	L-ring   rubber   for impeller



## Parts corr. Boumatic and Gascoigne Melotte

<b>1316230</b>	Contact ring   corr. Boumatic and Gascoigne Melotte 053604G
<b>1316225</b>	Mechanical seal   corr. Boumatic and Gascoigne Melotte G053605



## O-ring corr. Gascoigne Melotte

<b>1301392</b>	O-ring   corr. Gascoigne Melotte D242035
----------------	--



## Non-return valve corr. Gascoigne Melotte

<b>1300750</b>	Non-return valve   rubber   Ø 50 mm   corr. Gascoigne Melotte 381061
<b>1309843</b>	Non-return valve   rubber   Ø 44 mm   corr. Gascoigne Melotte
<b>1309844</b>	Non-return valve   rubber   Ø 42 mm   corr. Gascoigne Melotte 381473



## Milk pump corr. Westfalia

<b>1330195</b>	Milk pump   0,55 kW   in-and outlet Ø 32 mm   corr. Westfalia
<b>1330197</b>	Electric motor   0,55 kW   corr. Westfalia



## Impeller corr. Westfalia

<b>1330196</b>	Impeller   plastic   S/S shaft   corr. Westfalia 7038-2310-050
----------------	--



## Gasket corr. Westfalia

<b>1330199</b>	Gasket for housing   square   for 0,55 kW milk pump   corr. Westfalia 0007-2754-700
----------------	---



## Non-return valve corr. Westfalia

<b>1330198</b>	Non-return valve   rubber   corr. Westfalia 7038-5302-050
----------------	---



## Seal kit corr. Westfalia new model

<b>1310822</b>	Mechanical seal   for milk pump 1,1 kW   new model   corr. Westfalia 0004-2047-009
----------------	--



## Seal kit corr. Westfalia

<b>1310828</b>	Mechanical seal   for milk pump 1,5 kW   corr. Westfalia 7038-2145-000
----------------	--



## Graphite seal milk pump corr. Surge

**1316350** Graphite seal | corr. Surge 7750-0227-174



## Non-return valve corr. Westfalia

**1306972** Non-return valve | rubber | Ø 50 mm | corr. Westfalia 7038-2648-000



## Non-return valve corr. Strangko

**1306965** Non-return valve | rubber | Ø 50 mm | corr. Strangko Manovac



## Non-return valve corr. Miele

**1301951** Non-return valve | rubber | Ø 40 mm | corr. Miele 1311211



## Non-return valve corr. Lely

**1308144** Non-return valve | silicone | Ø 50 mm | corr. Lely A2-A3-A4



**1308145** Non-return valve | silicone | red | Ø 50 mm | corr. Lely A2-A3-A4



## S/S outlet

**1300672** Outlet | S/S | straight | Ø 32 mm | 3/8" BSP



**1300671** Outlet | S/S | straight | Ø 40/32 mm | 3/8" BSP

**1300670** Outlet | S/S | 90° | Ø 40/32 mm | 3/8" BSP



**1300669** Outlet | S/S | 90° | Ø 32 mm | 2 x 3/8" BSP

**1300668** Outlet | S/S | 90° | Ø 32 mm | 1 x 3/8" BSP

**1300680** Outlet | S/S | 90° | Ø 40 mm | 3/8" BSP | corr. DeLaval 998.956-80



**1300679** Outlet | S/S | 90° | Ø 32 mm | corr. DeLaval 958.282-81



## Drain valve

**1301362** Drain valve | nylon | 3/8" BSP

**1316232** Drain nut | plastic | corr. DeLaval 999.585-01



## Control unit Miele milk pump

**1330200** Control unit | new model | fitt. for Miele milk pump

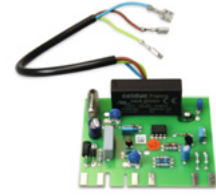

## Level control

**1310513** Level control | 70 cm | corr. DeLaval 965.230-86(87)

**1310510** Float ball | corr. DeLaval 965.215-80



Chapter 8

# MILK RECEIVING AND MILK MEASUREMENT

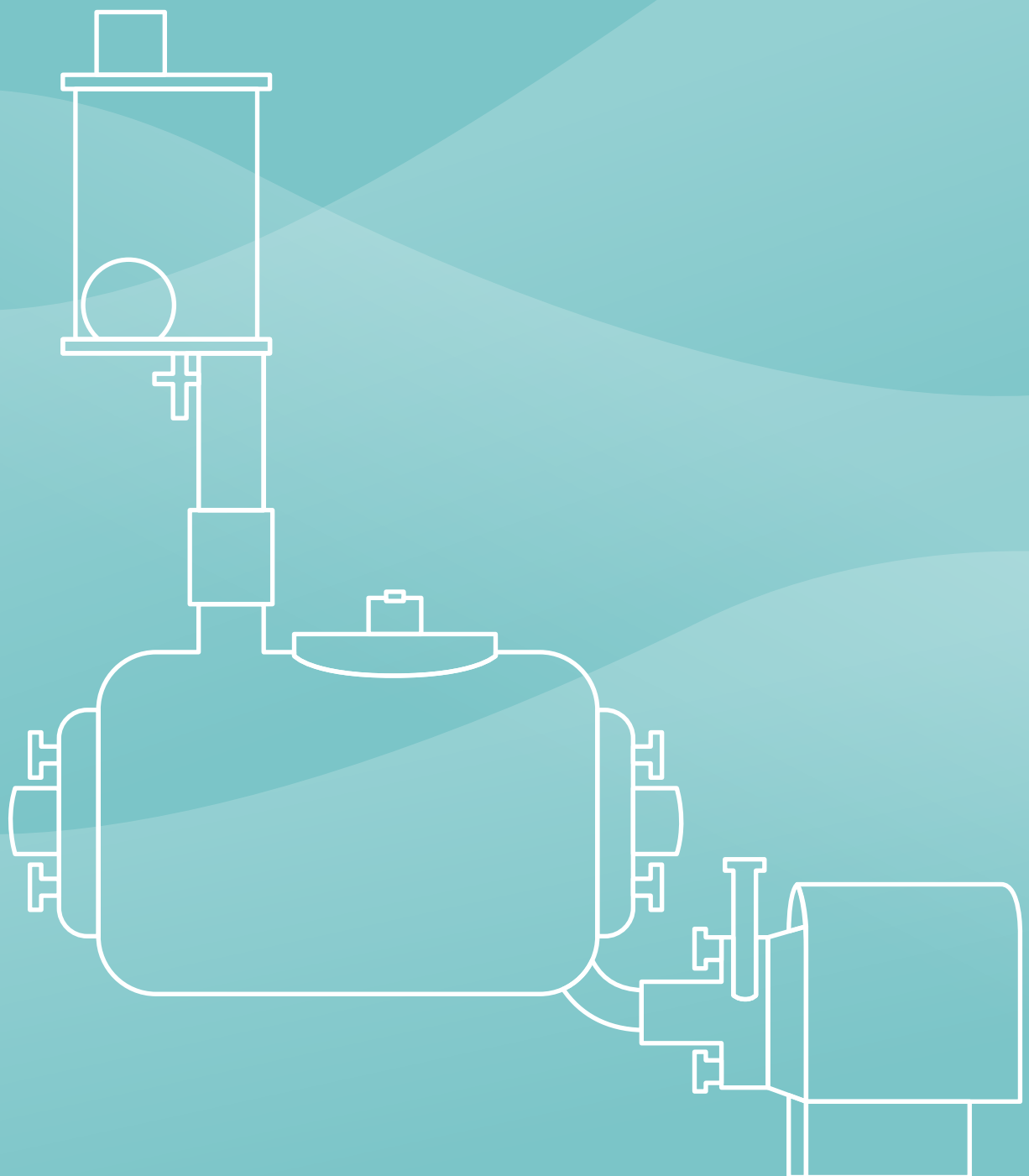

## Chapter 8 Milk receiving and milk measurement

Milk receiver unit complete	P130
Receiver	P130
Lid for milk receiver with outlet	P130
Lid 2 x outlet for milk receiver	P131
Lid blind for milk receiver	P131
Lid for milk receiver	P131
Lid for milk receiver	P131
Gasket for lid	P131
Spray plate	P131
Float ball	P132
Control level switch set	P132
Electrode	P132
Float	P132
Milk receiver vertical	P132
Sanitary trap 6 ltr.	P132
Sanitary trap 9 ltr.	P133
Sanitary trap Economic	P133
Sanitary trap horizontal	P133
Housing for sanitary traps corr. DeLaval	P133
Gasket corr. DeLaval	P133
Sprayer corr. DeLaval	P133
Milk filter with spring	P133
Milk filter with filter cage	P134
Parts for milk filter	P134
Stop corr. DeLaval	P134
U-ring	P134
T-plug corr. DeLaval	P134
Joint corr. DeLaval	P134
O-ring corr. DeLaval	P134
T-plug corr. Fullwood	P135
T-plug corr. Westfalia	P135
T-plug corr. Gascoigne Melotte	P135
U-ring corr. Fullwood	P135
U-ring corr. Surge	P135
Stop corr. Dairymaster	P135
Gasket corr. Surge	P135
Adapter for milk jar corr. DeLaval/Manus	P136
Adapter for milk jar corr. Melotte	P136

Adapter for milk jar corr. Surge/Miele	P136
Parts for adapter for milk jar	P136
Reduction rubber	P136
Milk entry for milk jar	P137
Stop for milk jar	P137
Repair kit corr. Afikim milk meter	P137
Repair kit corr. Afikim milk meter	P137
Valve piston for milk meter	P137
Right-angled hose	P137
Flange gasket for milk meter	P138
Gasket for milk meter	P138
Electro magnet	P138
Electrode block	P138
Diaphragm corr. Fullwood FW043111 and Boumatic	P138
Plunger	P138
Repair kit corr. Boumatic Perfection	P138
O-ring corr. Dairymaster	P139
Reed sensor corr. DeLaval	P139
Repair kit corr. DeLaval	P139
Parts corr. DeLaval Flomaster MM15	P139
Clip flowmaster	P139
Right-angled hose	P139
Repair kit corr. GEA Metatron	P140
Plunger	P140
Valve	P140
Diaphragm	P140
Milk meter	P140
Parts corr. Pulsameter 2 milk meter	P140
Measuring cup	P141
Sampling	P141
Bracket for sampling drain	P141
Upperpart	P141
Bottompart	P141
O-ring	P141
Valve	P141
Plate for air	P141
Milk meter	P142
Milk meter goats/sheep	P142
Milk flow indicator	P142
Valve	P142

Seal small	P142
Milk sampler Ambic	P142
Regulator Servo	P142
Switch house Servo	P143
Vacuum valve Servo	P143
Diaphragm Servo	P143
Handle for switch	P143
Microswitch	P143
Valve for SMW vacuum amplifier	P143
Diaphragm vacuum amplifier	P143
Gasket for milk jar	P144
Gasket for milk jar rubber	P144
Gasket for milk jar silicone	P144
Stop for milk jar	P144
Outlet for milk jar	P144



## Milk receiver unit complete

<b>1307797</b>	Milk receiver sanitary trap	60 liter 63/76 mm	milk pump 2 x lid Ø 50,8 mm	3 phase	0,55 kW	9 liter
<b>1307798</b>	Milk receiver sanitary trap	60 liter 63/76 mm	milk pump 2 x lid Ø 76 mm	3 phase	0,55 kW	9 liter
<b>1307799</b>	Milk receiver sanitary trap	60 liter 76/76 mm	milk pump 2 x lid Ø 50,8 mm	3 phase	0,55 kW	9 liter
<b>1307800</b>	Milk receiver sanitary trap	60 liter 76/76 mm	milk pump 2 x lid Ø 76 mm	3 phase	0,55 kW	9 liter
<b>1307825</b>	Milk receiver sanitary trap	60 liter 76/76 mm	milk pump 2 x lid Ø 76 mm	3 phase	0,75 kW	9 liter
<b>1307801</b>	Milk receiver sanitary trap	60 liter 76/76 mm	milk pump 2 x lid Ø 50,8 mm	3 phase	1,1 kW	9 liter
<b>1307802</b>	Milk receiver sanitary trap	60 liter 76/76 mm	milk pump 2 x lid Ø 76 mm	3 phase	1,1 kW	9 liter
<b>1307803</b>	Milk receiver sanitary trap	80 liter 76/76 mm	milk pump 2 x lid Ø 50,8 mm	3 phase	1,1 kW	9 liter
<b>1307804</b>	Milk receiver sanitary trap	80 liter 76/76 mm	milk pump 2 x lid Ø 76 mm	3 phase	1,1 kW	9 liter
<b>1308402</b>	Milk receiver sanitary trap	80 liter 76/76 mm	milk pump 2 x lid Ø 76 mm	1 phase	0,75 kW	9 liter
<b>1307805</b>	Milk receiver sanitary trap	100 liter 76/76 mm	milk pump 2 x lid Ø 76 mm	3 phase	1,1 kW	9 liter
<b>1308403</b>	Milk receiver sanitary trap	100 liter 76/76 mm	milk pump 2 x lid Ø 76 mm	1 phase	0,75 kW	9 liter



## Receiver

<b>1300630</b>	Receiver	60 ltr.	including accessories
<b>1300631</b>	Receiver	80 ltr.	including accessories
<b>1300632</b>	Receiver	100 ltr.	including accessories



## Lid for milk receiver with outlet

<b>1300657</b>	Lid	S/S	outlet Ø 40 mm
<b>1300658</b>	Lid	S/S	outlet Ø 50,8 mm
<b>1300659</b>	Lid	S/S	outlet Ø 63,5 mm
<b>1307820</b>	Lid	S/S	outlet Ø 70 mm
<b>1300660</b>	Lid	S/S	outlet Ø 76,2 mm
<b>1300608</b>	Lid	S/S	outlet Ø 102 mm
<b>1300651</b>	Gasket		



## Lid 2 x outlet for milk receiver

<b>1300662</b>	Lid   S/S   2 x outlet Ø 50,8 mm
<b>1300663</b>	Lid   S/S   2 x outlet Ø 63,5 mm
<b>1300661</b>	Lid   S/S   2 x outlet Ø 76,2 mm
<b>1300651</b>	Gasket



## Lid blind for milk receiver

<b>1300656</b>	Lid   S/S   blind
<b>1300651</b>	Gasket



## Lid for milk receiver

<b>1301164</b>	Lid   S/S   spray plate   2 x outlet Ø 18 mm
<b>1301162</b>	Lid   S/S   2 x outlet Ø 18 mm
<b>1301163</b>	Gasket



## Lid for milk receiver

<b>1307788</b>	Upper lid   S/S   Ø 49 mm hole   2 small pipes
----------------	--



## Gasket for lid

<b>1300651</b>	Gasket   221 x 180 x 6 mm   corr. Fullwood 71302 U-12-PL SS
<b>1301178</b>	Gasket   220 x 173 x 8-12 mm   corr. Fullwood 71305 M-12-W



## Spray plate

<b>1300640</b>	Spray plate   for sanitary trap
----------------	---------------------------------



## Float ball

<b>1301277</b>	Float ball   white   Ø 51 mm
<b>1301288</b>	Float ball   Ø 60 mm
<b>1301278</b>	Float ball   Ø 70 mm
<b>1301279</b>	Float ball   Ø 80 mm
<b>1301289</b>	Float ball   Ø 100 mm



## Control level switch set

<b>1300667</b>	Control level switch set
----------------	--------------------------



## Electrode

<b>1300666</b>	Electrode   Ø 32 mm
<b>1307733</b>	Electrode   Ø 49 mm
<b>1307732</b>	Rubber plug   for electrode Ø 32 mm
<b>1307734</b>	Rubber plug   for electrode Ø 49 mm



## Float

<b>1307789</b>	Float   Ø 49 mm
<b>1307731</b>	Rod   complete   550 D10
<b>1307790</b>	Rubber   for float Ø 49 mm



## Milk receiver vertical

<b>1307795</b>	Milk receiver   complete   vertical   37 ltr. tank   0,55 kW   3 phase
<b>1307796</b>	Milk receiver   complete   vertical   37 ltr. tank   0,55 kW   1 phase



## Sanitary trap 6 ltr.

<b>1300648</b>	Sanitary trap   6 ltr.   Ø 76/76 mm
<b>1300646</b>	Sanitary trap   6 ltr.   Ø 63/76 mm
<b>1307770</b>	Sanitary trap   6 ltr.   Ø 63/51 mm
<b>1300649</b>	Cylinder   plastic   6 ltr.



## Sanitary trap 9 ltr.

<b>1307736</b>	Sanitary trap   9 ltr.   Ø 76/88,9 mm
<b>1300647</b>	Sanitary trap   9 ltr.   Ø 76/76 mm
<b>1300645</b>	Sanitary trap   9 ltr.   Ø 63/76 mm
<b>1300650</b>	Cylinder   plastic   9 ltr.
<b>1300655</b>	Cylinder   glass   9 ltr.



## Sanitary trap Economic

<b>1309690</b>	Sanitary trap   9 ltr.   Ø 76/76 mm   model Economic
----------------	--



## Sanitary trap horizontal

<b>1307644</b>	Sanitary trap   horizontal   14 ltr.   Ø 88,9/88,9 mm
<b>1307648</b>	Sanitary trap   horizontal   14 ltr.   Ø 76/88,9 mm



## Housing for sanitary traps corr. DeLaval

<b>1300800</b>	Housing   sanitary trap   corr. DeLaval 995.762-01
<b>1300809</b>	Lid   sanitary trap   corr. DeLaval 995763-01



## Gasket corr. DeLaval

<b>1300802</b>	Gasket   large   corr. DeLaval 995.837-01
<b>1300804</b>	Gasket   bottom   corr. DeLaval 995.776-01



## Sprayer corr. DeLaval

<b>1300806</b>	Sprayer   corr. DeLaval 997.541-01
----------------	------------------------------------



## Milk filter with spring

<b>1300677</b>	Milk filter   spring   Ø 32 mm   560 mm length
<b>1307813</b>	Milk filter   spring   Ø 32 mm   615 mm length
<b>1307812</b>	Spring   only   560 mm length
<b>1307814</b>	Spring   only   615 mm length



## Milk filter with filter cage

<b>1300675</b>	Milk filter   filter cage   Ø 32 mm   310 mm length
<b>1307781</b>	Milk filter   filter cage   Ø 32 mm   560 mm length
<b>1307782</b>	Filter cage   only   310 mm length
<b>1307783</b>	Filter cage   only   560 mm length



## Parts for milk filter

<b>1307784</b>	Nut   plastic
<b>1307785</b>	Outlet   straight



## Stop corr. DeLaval

<b>1316460</b>	Stop   milk filter   320 mm   corr. DeLaval 958.313-01
----------------	--



## U-ring

<b>1301374</b>	U-ring   corr. Manus and DeLaval
<b>1314130</b>	U-ring   corr. DeLaval 951.507-01



## T-plug corr. DeLaval

<b>1316465</b>	T-plug   Milk filter   620 mm   corr. DeLaval 968.324-01
----------------	--



## Joint corr. DeLaval

<b>1316463</b>	Joint   for PVC Milk filter   320 mm   corr. DeLaval 958.096-01
----------------	---



## O-ring corr. DeLaval

<b>1301369</b>	O-ring   Ø 25 x 5 mm   corr. DeLaval 68085
----------------	--



## T-plug corr. Fullwood

1307810 T-plug | milk filter | corr. Fullwood



## T-plug corr. Westfalia

1307811 T-plug | milk filter | corr. Westfalia 7038-2284-020



## T-plug corr. Gascoigne Melotte

1307042 T-plug | milk filter | corr. Gascoigne Melotte T242013



## U-ring corr. Fullwood

1300676 U-ring | rubber | milk filter | corr. Fullwood



## U-ring corr. Surge

1330033 U-ring | rubber | milk filter | corr. Surge 1½" Ø 47x36x6 mm

1330034 U-ring | rubber | milk filter | corr. Surge 2" Ø 59x36x6 mm



## Stop corr. Dairymaster

1316320 Stop | milk filter | corr. Dairymaster FL24



## Gasket corr. Surge

1330061 Gasket | milk filter | 1½" | corr. Surge

1330062 Gasket | milk filter | 2" | corr. Surge



## Adapter for milk jar corr. DeLaval/Manus

<b>1301249</b>	Adapter for milk jar   right-angled   16-16-32 mm   with hole   corr. DeLaval/Manus
<b>1301442</b>	Adapter for milk jar   right-angled   16-16-32 mm   without hole for ball lever   corr. DeLaval/Manus
<b>1301251</b>	Adapter for milk jar   right-angled   16-16-38 mm   with hole   corr. DeLaval/Manus
<b>1301263</b>	Adapter for milk jar   right-angled   16-16-38 mm   without hole for ball lever   corr. DeLaval/Manus



## Adapter for milk jar corr. Melotte

<b>1309448</b>	Adapter for milk jar   right-angled   38-22-16 mm   corr. Melotte
<b>1309446</b>	Adapter for milk jar   right-angled   38-22-16 mm   without hole for ball lever   corr. Melotte



## Adapter for milk jar corr. Surge/Miele

<b>1301253</b>	Adapter for milk jar   16-16-32 mm   corr. Surge/Gascoigne Melotte/Miele
<b>1301252</b>	Adapter for milk jar   16-16-38 mm   with hole   corr. Surge/Gascoigne Melotte/Miele
<b>1307056</b>	Adapter for milk jar   16-16-38 mm   without hole for ball lever   corr. Surge



## Parts for adapter for milk jar

<b>1301256</b>	Ball valve   Ø 22 mm
<b>1301255</b>	Lever for ball valve
<b>1301257</b>	Sampling tap   corr. Manus 222021



## Reduction rubber

<b>1301254</b>	Reduction   rubber   Ø 38-32 mm
----------------	---------------------------------



## Milk entry for milk jar

<b>1307058</b>	Milk entry   Ø 38 x 45 mm
<b>1301245</b>	Milk entry   Ø 40 x 50 mm
<b>1301243</b>	Milk entry   Ø 40 x 58 mm
<b>1301244</b>	Milk entry   Ø 50 x 58 mm
<b>1307059</b>	Milk entry   Ø 62 x 76 mm
<b>1307060</b>	Milk entry   Ø 70 x 76 mm
<b>1309866</b>	Milk entry   Ø 76 x 76 mm



## Stop for milk jar

<b>1310638</b>	Stop   Ø 59 mm
<b>1310639</b>	Stop   Ø 76 mm



## Repair kit corr. Afikim milk meter

<b>1312155</b>	Repair kit   Milk meter   corr. Afikim 4098018
----------------	--



## Repair kit corr. Afikim milk meter

<b>1312170</b>	Repair kit   Milk meter   2 x diaphragm Ø 51 mm and 1 x gasket   corr. Afikim 4098072
<b>1312160</b>	Repair kit   Milk meter   2 x gasket and 1x socket   corr. Afikim 4098095



## Valve piston for milk meter

<b>1307368</b>	Valve piston   12 ltr.   new model   corr. Fullwood, Manuflow, Afikim
----------------	---



## Right-angled hose

<b>1301192</b>	Right-angled hose   rubber   Ø 19 x 32 mm   corr. Fullwood, Manuflow, Afikim 33409
<b>1310988</b>	Right-angled hose   silicone   blue   Ø 19 x 34 mm   corr. Fullwood, Manuflow, Afikim





## Flange gasket for milk meter

**1301685** Gasket | for flange 12 ltr. | new model | corr. Fullwood 02002, Manuflow, Afikim C733428



## Gasket for milk meter

**1301190** Gasket | rectangle | Ø 19 x 32 mm | corr. Fullwood 01954, Manuflow, Afikim C733420



## Electro magnet

**1307372** Electro magnet | corr. Afimilk MM85 and Fullwood 033414



## Electrode block

**1307385** Electrode block | 10 mtr. cable | corr. Afimilk and Fullwood 033412



## Diaphragm corr. Fullwood FW043111 and Boumatic

**1308517** Diaphragm | for inverting amplifier | corr. Fullwood FW043111 and Boumatic



## Plunger

**1311647** Plunger | 1-piece | new model | corr. Boumatic Sensor 4098072



## Repair kit corr. Boumatic Perfection

**1311645** Repair kit | 6-pieces | corr. Boumatic Perfection

**1311648** Seal

**1311651** O-ring | silicone | red

**1311646** Diaphragm | white



## O-ring corr. Dairymaster

**1316290** O-ring | corr. Dairymaster RE211



## Reed sensor corr. DeLaval

**1309788** Reed sensor | 3 mtr. cable | corr. DeLaval 984.482-01

**1309799** Reed sensor | 20 mtr. cable | corr. DeLaval 984.482-03



## Repair kit corr. DeLaval

**1316750** Repair kit | Milk meter | 5-pieces | corr. DeLaval 985.103-80

**1316700** Repair kit | Milk meter | 3-pieces | corr. DeLaval 989.836-80

*Parts also separate available*



## Parts corr. DeLaval Flomaster MM15

**1316752** Joint | silicone | blue | corr. DeLaval Flomaster 988.879-01

**1316754** Gasket | black | corr. DeLaval Flomaster 987.735-01

**1316756** Bellow | corr. DeLaval Flowmaster 984.526-01

**1310573** Gasket | corr. DeLaval Flomaster MM15 997.162-01

**1310574** Cap | rubber | corr. DeLaval Flomaster MM15 997.176-01

**1312053** Grommet | corr. DeLaval Flomaster 968.370-01

**1316758** Diaphragm | for shut-off valve | corr. DeLaval Flomaster 917.345-01



## Clip flowmaster

**1334010** Clip | corr. DeLaval 997.165-01



## Right-angled hose

**1312068** Right-angled hose | Ø 20 x 520 mm | corr. Flomaster Pro MM15 967.458-02



## Repair kit corr. GEA Metatron

<b>1311635</b>	Repair kit   8-pieces   corr. GEA Metatron
<b>1311630</b>	Gasket   for lid   corr. GEA Metatron
<b>1311621</b>	Sealing cap   corr. GEA Metatron
<b>1311638</b>	Valve   corr. Westfalia Metatron 7161-1731-080
<b>1312087</b>	Diaphragm   silicone   Ø 54 mm   with hole   corr. GEA Visoflow/Metatron 7161-1702-040
<b>1312088</b>	Diaphragm   silicone   Ø 54 mm   without hole   corr. GEA Visoflow/Metatron 7161-1702-040



## Plunger

<b>1311633</b>	Plunger   corr. Westfalia Visoflow
----------------	------------------------------------



## Valve

<b>1312083</b>	Valve   corr. Westfalia Visoflow 7053-1721-030
----------------	--



## Diaphragm

<b>1310387</b>	Diaphragm   silicone   Ø 54 mm   corr. Westfalia 0004-2304-890
<b>1312088</b>	Diaphragm   silicone   Ø 54 mm   without hole   corr. GEA Visoflow/Metatron 7161-1702-040



## Milk meter

<b>1310931</b>	Milk meter   without sensor   left   corr. Pulsameter 2
<b>1310930</b>	Milk meter   without sensor   right   corr. Pulsameter 2



## Parts corr. Pulsameter 2 milk meter

<b>1310955</b>	Repair kit   corr. Pulsameter 2
<b>1310942</b>	Flap   for air admission
<b>1310936</b>	Diaphragm   Ø 48 mm   for shut-off
<b>1310948</b>	Diaphragm   Ø 63 mm   for cleaning valve
<b>1310969</b>	Gasket   for measuring cup
<b>1310980</b>	Washer
<b>1310943</b>	Gasket



## Measuring cup

**1310939** Measuring cup | corr. Pulsameter 2



## Sampling

**1310951** Milk meter sampling | complete | without bottle | corr. Pulsameter 2



## Bracket for sampling drain

**1310940** Bracket for sampling drain | with spring | corr. Pulsameter 2



## Upperpart

**1310945** Upperpart | right | for Milk meter | corr. Pulsameter 2

**1310946** Upperpart | left | for Milk meter | corr. Pulsameter 2



## Bottompart

**1310941** Bottompart | corr. Pulsameter 2



## O-ring

**1310952** O-ring | corr. Pulsameter 2



## Valve

**1310953** Valve | with pin | corr. Pulsameter 2



## Plate for air

**1310954** Plate for air admission | corr. Pulsameter 2



## Milk meter

- |                |  |
|----------------|--|
| <b>1312115</b> | Milk meter   corr. Waikato MK5 31 kg (68 LB) |
| <b>1312120</b> | Milk meter   original   Waikato MK5 30 ltr.  |



## Milk meter goats/sheep

- |                |   |
|----------------|---|
| <b>1312110</b> | Milk meter   goats and sheep   corr. Waikato MK4 4,7 ltr. |
|----------------|---|



## Milk flow indicator

- |                |   |
|----------------|---|
| <b>1301205</b> | Milk flow indicator   for ACR   3 meter cable |
| <b>1307361</b> | Lid   |
| <b>1307362</b> | Diaphragm                                     |



## Valve

- |                |   |
|----------------|---|
| <b>1309966</b> | Valve   with shaft   for Milk meter   corr. Gascoigne Melotte D382869 |
|----------------|---|



## Seal small

- |                |   |
|----------------|---|
| <b>1309968</b> | Seal   small   for Milk meter   corr. Gascoigne Melotte D382724 |
|----------------|---|



## Milk sampler Ambic

- |                |                                 |
|----------------|---------------------------------|
| <b>1309901</b> | Milk sampler   200 ml   Ambic   |
| <b>1310294</b> | Repair kit   Ambic              |
| <b>1310833</b> | Cup   only   Ambic              |
| <b>1310834</b> | Body sealing   Ambic            |
| <b>1310301</b> | Kit o-rings   12 pieces   Ambic |



## Regulator Servo

- |                |   |
|----------------|---|
| <b>1307345</b> | Regulator   corr. Fullwood Servo 024029 |
|----------------|---|



## Switch house Servo

**1307346** Switch house | for regulator | corr. Fullwood Servo 024042



## Vacuum valve Servo

**1307349** Vacuum valve | Ø 16 mm | with vent | corr. Fullwood 032335

**1307350** Vacuum valve | Ø 22 mm | without vent | corr. Fullwood 032351



## Diaphragm Servo

**1307348** Diaphragm | with hole | for Ø 16 mm valve | corr. Fullwood 032337

**1307347** Diaphragm | without hole | for Ø 22 mm valve | corr. Fullwood 032352



## Handle for switch

**1316479** Handle for switch | corr. DeLaval Servo 966.356-01

**1330076** Spring | S/S | corr. DeLaval Servo 966.359-02



## Microswitch

**1330051** Microswitch | corr. DeLaval PE/CE 965.226-82

**1330055** Microswitch | corr. Manus 966.019-01



## Valve for SMW vacuum amplifier

**1310616** Valve | vacuum amplifier | corr. DeLaval 996.751-01

**1310605** Top valve diaphragm | SMW valve | corr. DeLaval 996.748-01



## Diaphragm vacuum amplifier

**1311082** Diaphragm | vacuum amplifier | corr. DeLaval 958.689-01



## Gasket for milk jar

**1316220** Gasket for milk jar | new model | corr. DeLaval 965.640-01



## Gasket for milk jar rubber

**1301395** Gasket for milk jar | rubber | for glass jar DeLaval | Ø 305 mm



## Gasket for milk jar silicone

**1308820** Gasket for milk jar | silicone | Ø 225 x 195 x 15 mm | corr. DeLaval 27315



## Stop for milkjar

**1310638** Stop | Ø 59 mm

**1310639** Stop | Ø 76 mm



## Outlet for milk jar

**1308061** Outlet | milk jar | corr. Westfalia 7009-2864-140



Chapter 9

# MILK COOLING

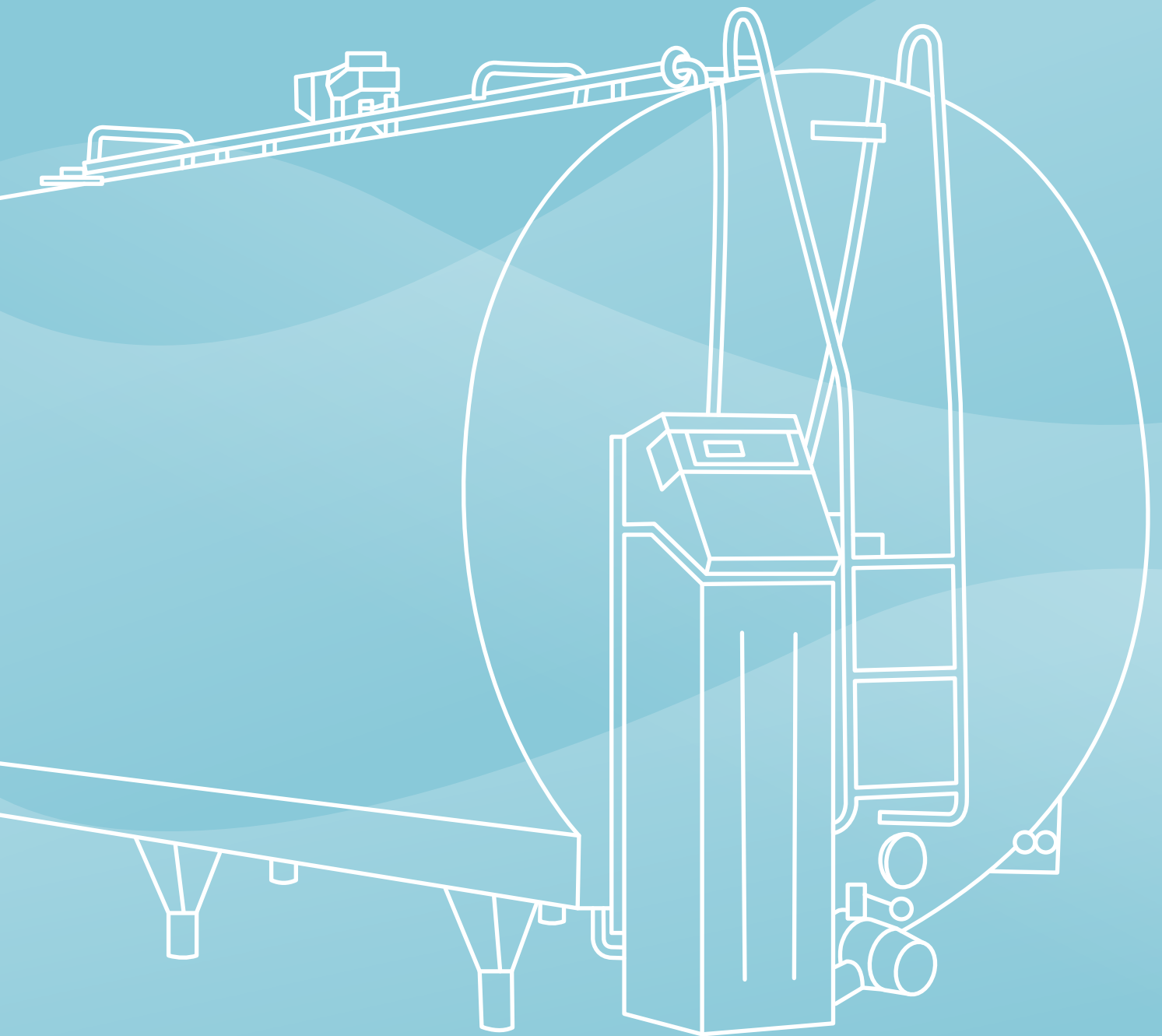



## Chapter 9 Milk cooling

SIREM agitator motor	P146
Drive motor for agitator	P147
SIREM washing pump	P147
Welba milk temperature regulator MRF-M	P147
Welba milk temperature regulator ETM-W300	P147
Welba milk temperature regulator MPR-M	P148
Welba control box	P148
Reed sensor	P148
Temperature sensor DeLaval AC, TE en Excellent CL2	P148
Temperature sensor corr. Japy-Westfalia Expert A3/A4	P148
Fan	P148
Plastic cover	P148
Deflector	P149
Repair kit for SIREM	P149
Capacitors	P149
Bushing	P149
First double gear types	P150
Second double gear types	P150
S/S pipe cooler	P150
Water magnetic valve	P150

## SIREM agitator motor

<b>1340005</b>	Agitator motor   SIREM   R1C 225 D1B C corr. Alfa-Prominox and Fabdec
<b>1340008</b>	Agitator motor   SIREM   R 322 5D 1 B corr. Alfa-Prominox
<b>1340011</b>	Agitator motor   SIREM   R 245 D2B fitt. round closed DeLaval tank
<b>1340014</b>	Agitator motor   SIREM   R3 225 D2B corr. Packo
<b>1340017</b>	Agitator motor   SIREM   R1C 225 D2B C corr. Japy 25-30 RPM
<b>1340020</b>	Agitator motor   SIREM   R1C 225 D2B C corr. Serap
<b>1340023</b>	Agitator motor   SIREM   R1C 225 D2B C corr. Japy 21-25 RPM
<b>1340026</b>	Agitator motor   SIREM   R 245 D1B
<b>1340029</b>	Agitator motor   SIREM   R3 225 D2B
<b>1340032</b>	Agitator motor   SIREM   R1C 225 D2B C
<b>1340035</b>	Agitator motor   SIREM   R1C 225 F2B C
<b>1340038</b>	Agitator motor   SIREM   R1C 225 F2B C corr. Japy 48-58 RPM
<b>1340041</b>	Agitator motor   SIREM   R1C 225 F1B C corr. Fabdec
<b>1340047</b>	Agitator motor   SIREM   R1C 225 F2B C corr. Japy 21-25 RPM
<b>1340050</b>	Agitator motor   SIREM   R 225 F2B corr. Japy
<b>1340053</b>	Agitator motor   SIREM   R 245 F2B
<b>1340056</b>	Agitator motor   SIREM   R1C 225 F2B C
<b>1340062</b>	Agitator motor   SIREM   R 225 F6B
<b>1340065</b>	Agitator motor   SIREM   R 225 F2B corr. Röka
<b>1340068</b>	Agitator motor   SIREM   R1C 225 H2B C corr. Packo
<b>1340071</b>	Agitator motor   SIREM   R1C 225 M6B C corr. Etscheid and Fabdec
<b>1340074</b>	Agitator motor   SIREM   R1C 225 M2B C corr. Müller and Fabdec
<b>1340077</b>	Agitator motor   SIREM   R1C 245 M2B
<b>1340080</b>	Agitator motor   SIREM   R 245 M6B corr. Müller and Etscheid
<b>1340083</b>	Agitator motor   SIREM   R1C 245 NP7 B corr. Packo Fullwood 30 RPM
<b>1340086</b>	Agitator motor   SIREM   R1C 245 NP7 B corr. Packo Fullwood 23 RPM
<b>1340089</b>	Agitator motor   SIREM   R3 245 N2B
<b>1340090</b>	Agitator motor   SIREM   R1C 245 NOB Müller
<b>1340092</b>	Agitator motor   SIREM   R1C 245 NP5 B corr. Röka and Fabdec
<b>1340093</b>	Agitator motor   SIREM   R3 245 NP 5B
<b>1340095</b>	Agitator motor   SIREM   R1C 245 NSB R corr. Röka
<b>1340098</b>	Agitator motor   SIREM   R1C 245 N2B R
<b>1340101</b>	Agitator motor   SIREM   R1C 245 NSB R corr. Röka and Fabdec
<b>1340104</b>	Agitator motor   SIREM   R1C 245 N2B R corr. Alfa-Prominox and Japy
<b>1340107</b>	Agitator motor   SIREM   R3 245 NP7 B corr. Packo Fullwood 30 RPM
<b>1340110</b>	Agitator motor   SIREM   R3 245 NP7 B corr. Packo 23 RPM
<b>1340113</b>	Agitator motor   SIREM   R1C 245 NP5 B corr. Röka and Alfa-Prominox 23 RPM
<b>1340116</b>	Agitator motor   SIREM   R1C 245 NP5 B corr. Röka and Alfa-Prominox 32 RPM



<b>1340119</b>	Agitator motor   SIREM   R1C 245 L5B corr. Alfa-Prominox
<b>1340121</b>	Agitator motor   SIREM   R1CF 225 F4BC

## Drive motor for agitator

<b>1340125</b>	Drive motor   for agitator   dark blue   corr. DeLaval HCA 98043398-86
<b>1340128</b>	Drive motor   for agitator   light blue   corr. DeLaval HCA 98043398-86



## SIREM washing pump

<b>1340335</b>	Washing pump   SIREM   PB1 C270 H4B corr. Alfa-Prominox, Fabdec
<b>1340338</b>	Washing pump   SIREM   PB3 270 H4B
<b>1340341</b>	Washing pump   SIREM   PB1 C285 H4B corr. Alfa-Prominox
<b>1340344</b>	Washing pump   SIREM   PB3 285 H4B corr. Alfa-Prominox
<b>1340347</b>	Washing pump   SIREM   PB3 270 H1B corr. Alfa-Prominox
<b>1340350</b>	Washing pump   SIREM   PB1 C250 H1B corr. Röka, Fabdec
<b>1340353</b>	Washing pump   SIREM   PB1 C285 H1B
<b>1340356</b>	Washing pump   SIREM   PB1 C270 H1B corr. Fabdec
<b>1340359</b>	Washing pump   SIREM   PB3 250 H1B corr. Röka
<b>1340365</b>	Washing pump   SIREM   PB1 C270 K4B
<b>1340368</b>	Washing pump   SIREM   PB1 C80 K1B corr. Fabdec
<b>1340371</b>	Washing pump   SIREM   PB 80 K2B corr. Etscheid, Packo, Japy
<b>1340374</b>	Washing pump   SIREM   PB C80 K2B corr. Etscheid, Packo, Japy
<b>1340377</b>	Washing pump   SIREM   PB3 270 K1B corr. Packo
<b>1340380</b>	Washing pump   SIREM   PB 80 K1B



## Welba milk temperature regulator MRF-M

<b>1340416</b>	Milk temperature regulator   Welba   MRF-M
----------------	--



## Welba milk temperature regulator ETM-W300

<b>1340413</b>	Milk temperature regulator   Welba   ETM-W300
----------------	---



## Welba milk temperature regulator MPR-M

**1340419** Milk temperature regulator | Welba | MPR-M



## Welba control box

**1340407** Control box | Welba | WTS-100 G1

**1340410** Control box | Welba | WTS-100-2

**1340411** Temperature probe | for Welba WTS-100-2



## Reed sensor

**1309788** Reed sensor | 3 mtr. cable | corr. DeLaval 984.482-01

**1309799** Reed sensor | 20 mtr. cable | corr. DeLaval 984.482-03



## Temperature sensor DeLaval AC, TE en Excellent CL2

**1340422** Temperature sensor | 2,2 mtr. | original | DeLaval AC, TE and Excellent CL2

**1340425** Temperature sensor | 5 mtr. | original | DeLaval AC, TE and Excellent CL2



## Temperature sensor corr. Japy-Westfalia Expert A3/A4

**1340428** Temperature sensor | 7 mtr. | corr. Japy-Westfalia Expert A3/A4



## Fan

**1340320** Fan | washing pumps



## Plastic cover

**1340392** Cover | plastic | for washing pumps type H and K



## Deflector

**1340389** Deflector | for washing pumps type H and K



## Repair kit for SIREM

**1340362** Repair kit | for SIREM washing pumps type H

**1340383** Repair kit | for SIREM washing pumps type K



## Capacitors

**1340284** Capacitor | 1,25 $\mu$ F

**1340287** Capacitor | 2 $\mu$ F

**1340290** Capacitor | 3 $\mu$ F

**1340293** Capacitor | 4 $\mu$ F

**1340296** Capacitor | 5 $\mu$ F

**1340299** Capacitor | 7 $\mu$ F

**1340302** Capacitor | 8 $\mu$ F

**1340305** Capacitor | 10 $\mu$ F | for washing pump PB1 C250 H1B

**1340308** Capacitor | 18 $\mu$ F

**1340311** Capacitor | 20 $\mu$ F



## Bushing

**1340212** Bushing 1 | for second double gear type D and H

**1340215** Bushing 2 | for second double gear type D and H

**1340218** Bushing | for first and second gear type F and first gear type D and H

**1340221** Bushing | for second double gear type M, L and N

**1340224** Plate | for bushing second double gear type M, L and N

**1340220** Bushing | type 1 | DZ F/D/H | 2 pieces

**1340222** Bushing | type 2 | DZ D/H | 1 piece

**1340223** Bushing | type 2 | DZ D/H | 1 piece

**1340227** Bushing | type for first double gear type M, L and N

**1340230** Plate | for bushing first double gear type M, L and N



## First double gear types

<b>1340134</b>	First double gear   type F, 62 RPM
<b>1340137</b>	First double gear   type F, 48 RPM
<b>1340140</b>	First double gear   type F, Celoron, 21/30/40 RPM, 62/12
<b>1340143</b>	First double gear   type F, 21/30/40 RPM, 62/12
<b>1340146</b>	First double gear   type F, Celoron, 48 RPM, 62/8
<b>1340149</b>	First double gear   type D and H, Celoron, 10,5/21 RPM, 62/9
<b>1340152</b>	First double gear   type D and H, Celoron, 25/30/39 RPM, 54/11
<b>1340155</b>	First double gear   type D and H, Celoron, 48 RPM, 54/11
<b>1340158</b>	First double gear   type M and L, Celoron, 30 RPM, 46/13
<b>1340161</b>	First double gear   type N, Celoron, 22/23 RPM, 42/10
<b>1340164</b>	First double gear   type N, Celoron, 25 RPM
<b>1340167</b>	First double gear   type N, Celoron, 32 RPM, 42/13
<b>1340170</b>	First double gear   type P, Celoron, 125 RPM
<b>1340173</b>	First double gear   type F, Celoron, 125 RPM, 62/14



## Second double gear types

<b>1340176</b>	Second double gear   type F, 30 RPM, 49/14
<b>1340179</b>	Second double gear   type F 21 RPM
<b>1340182</b>	Second double gear   type F, 40 RPM, 49/17
<b>1340185</b>	Second double gear   type D and H, steel, 21/30 RPM, 52/9
<b>1340188</b>	Second double gear   type D and H, steel, 25 RPM, 52/8
<b>1340191</b>	Second double gear   type M and L, steel, 30 RPM
<b>1340194</b>	Second double gear   type F, steel, 30 RPM, 49/14
<b>1340197</b>	Second double gear   type N, steel, 23 RPM, 49/9
<b>1340200</b>	Second double gear   type N, steel, 32 RPM, 49/9
<b>1340203</b>	Second double gear   type N, steel, 25 RPM
<b>1340206</b>	Second double gear   type N, hardened steel, 23 RPM, 49/9



## S/S pipe cooler

<b>1340434</b>	Pipe cooler   S/S   1" connection
----------------	-----------------------------------



## Water magnetic valve

<b>1340455</b>	Water magnetic valve   1"   for milke plate cooler
----------------	--



Chapter 10

# MILK BUCKETS AND MOBILE MILKING

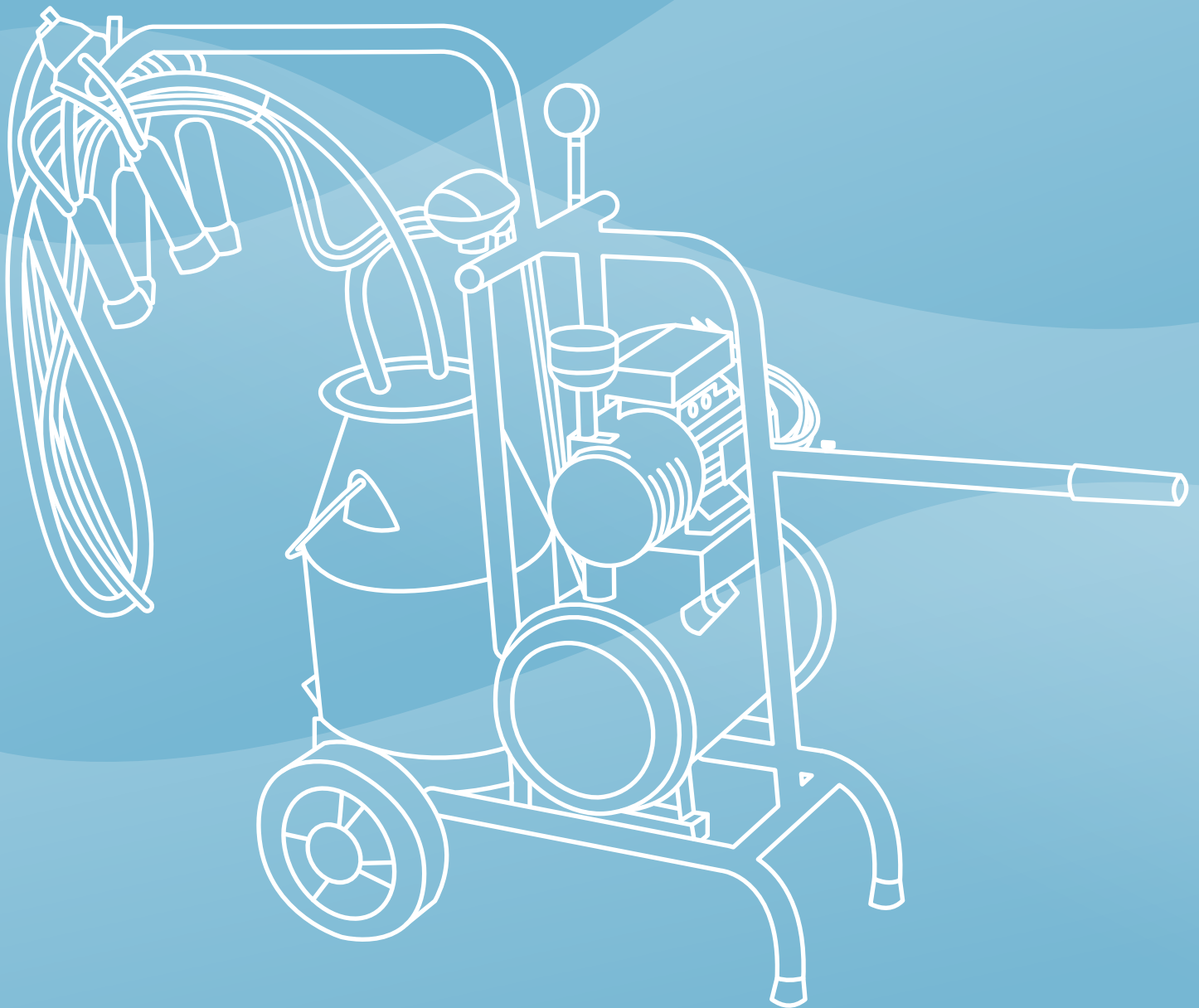

## Chapter 10 Milk buckets and mobile milking

Milk bucket cleaning bracket universal	P152
Milk bucket complete for cows	P152
Milk buckets S/S	P152
Milk buckets plastic	P152
Milk bucket eco red 34 liter	P153
Lid S/S 117 mm one inlet	P153
Lid S/S 117 mm two 90° inlets	P153
Lid S/S 117 mm two inlets	P153
Lid S/S 117 mm two 90° inlets	P153
Lid S/S 143 mm	P154
Control lid flat	P154
Control lid	P154
Control lid	P154
Control lid for aluminium buckets	P154
Control lid with non return valve	P154
Control lid blue and green	P155
Libero lid	P155
Lid corr. Gascoigne Melotte	P155
Transport lid rubber	P155
Gasket for lid DeLaval 20029	P155
Gasket for lid corr. Fullwood 71305 M-12-W	P155
Gasket for lid corr. Fullwood 71302 U-12-PL SS	P156
Gasket for lid corr. Westfalia 0007-3030-710	P156
Rubber valve for vacuum tank	P156
Mini milker Friesland with S/S bucket for cow	P156
Mini milker Friesland galvanized with S/S bucket for cow	P156
Mini milker Friesland with plastic bucket for cow	P156
Mini milker Friesland galvanized plastic bucket for cow	P157
Mini milker Friesland oil lubricated for cow	P157
Mini milker Groningen S/S bucket for cow	P157
Mini milker Groningen galvanized S/S bucket for cow	P157
Mini milker Groningen plastic bucket for cow	P157
Mini milker Flevoland for cow	P158
Mini milker Brabant for cow	P158
Mini milker Holland for cow	P158
Mini milker Moby for cow	P158
Parts for mini milkers for cow	P158



## Milk bucket cleaning bracket universal

<b>1300029</b>	Milk bucket cleaning bracket   S/S   suitable for every milking-machine
----------------	---



## Milk bucket complete for cows

<b>1307538</b>	Milk bucket   S/S   30 ltr.   complete
<b>1314008</b>	Milking cluster   complete   also for mini milkers and milk buckets
<b>1309857</b>	Pulsator   Nedlac 2000   S/S lid   60:40
<b>1310521</b>	Milk bucket   plastic   blue   30 ltr.   complete
<b>1308347</b>	Pulsator   Nedlac 2000   blue lid   60:40
<b>1310524</b>	Milk bucket   plastic   green   30 ltr.   complete
<b>1310411</b>	Pulsator   Nedlac 2000   grüner Deckel   60:40
<b>1310527</b>	Milk bucket   plastic   orange   30 ltr.   complete
<b>1309857</b>	Pulsator   Nedlac 2000   S/S lid   60:40



## Milk buckets S/S

<b>1301152</b>	Milk bucket   S/S   25 ltr.   handle height 117 mm
<b>1310310</b>	Milk bucket   S/S   25 ltr.   handle height 143 mm
<b>1301153</b>	Milk bucket   S/S   30 ltr.   handle height 117 mm
<b>1309598</b>	Milk bucket   S/S   30 ltr.   handle height 143 mm
<b>1301154</b>	Milk bucket   S/S   34 ltr.   handle height 117 mm
<b>1310767</b>	Milk bucket   S/S   34 ltr.   handle height 143 mm



## Milk buckets plastic

<b>1300030</b>	Milk bucket   plastic   blue   30 ltr.   handle height 117 mm
<b>1300031</b>	Milk bucket   plastic   blue   30 ltr.   handle height 143 mm
<b>1300032</b>	Milk bucket   plastic   blue   30 ltr.   handle height 186 mm
<b>1310760</b>	Milk bucket   plastic   green   30 ltr.   handle height 117 mm
<b>1309760</b>	Milk bucket   plastic   green   30 ltr.   handle height 143 mm
<b>1307642</b>	Milk bucket   plastic   green   30 ltr.   handle height 186 mm
<b>1310623</b>	Milk bucket   plastic   orange   30 ltr.   handle height 117 mm
<b>1307641</b>	Milk bucket   plastic   orange   30 ltr.   handle height 143 mm
<b>1310624</b>	Milk bucket   plastic   orange   30 ltr.   handle height 186 mm
<b>1310829</b>	Milk bucket   plastic   red   30 ltr.   handle height 117 mm
<b>1310820</b>	Milk bucket   plastic   red   30 ltr.   handle height 143 mm



<b>1310831</b>	Milk bucket   plastic   red   30 ltr.   handle height 186 mm
<b>1307638</b>	Handle   aluminium   height 117 mm
<b>1307639</b>	Handle   aluminium   height 143 mm
<b>1307640</b>	Handle   aluminium   height 186 mm
<b>1307643</b>	Set closures   for aluminium handles

## Milk bucket eco red 34 liter

<b>1340001</b>	Eco milk bucket   red   34 liter
----------------	----------------------------------



## Lid S/S 117 mm one inlet

<b>1307633</b>	Lid   S/S   1 inlet Ø 14 x 17 mm   handle height 117 mm   complete
<b>1309536</b>	Lid   S/S   1 inlet Ø 16 x 19 mm   handle height 117 mm   complete
<b>1301175</b>	Gasket for lid   Ø 200 x 160 x 9 mm   corr. DeLaval 958.170-01
<b>1301160</b>	Handwheel   plastic   for S/S lids   corr. DeLaval 26341



## Lid S/S 117 mm two 90° inlets

<b>1307634</b>	Lid   S/S   2 inlets Ø 14 x 17 mm   handle height 117 mm   complete
<b>1301175</b>	Gasket for lid   Ø 200 x 160 x 9 mm   corr. DeLaval 958.170-01
<b>1301160</b>	Handwheel   plastic   for S/S lids   corr. DeLaval 26341



## Lid S/S 117 mm two inlets

<b>1310840</b>	Lid   S/S   2 inlets Ø 16 x 19 mm   handle height 117 mm   complete
<b>1301175</b>	Gasket for lid   Ø 200 x 160 x 9 mm   corr. DeLaval 958.170-01



## Lid S/S 117 mm two 90° inlets

<b>1310349</b>	Lid   S/S   2 inlets Ø 14 x 16 mm   handle height 117 mm   complete
<b>1301175</b>	Gasket for lid   Ø 200 x 160 x 9 mm   corr. DeLaval 958.170-01



## Lid S/S 143 mm

<b>1309706</b>	Lid   S/S   1 inlet Ø 14 x 17 mm   handle height 143 mm   complete   corr. Westfalia
<b>1301175</b>	Gasket for lid   Ø 200 x 160 x 9 mm   corr. DeLaval 958.170-01



## Control lid flat

<b>1309594</b>	Control lid   2 inlets Ø 12 x 17 mm   complete
<b>1309678</b>	Control lid   2 inlets Ø 16 x 20 mm   complete
<b>1307526</b>	Gasket for lid   rubber



## Control lid

<b>1301807</b>	Control lid   plastic   2 inlets Ø 15 x 21 mm   complete
<b>1307645</b>	Gasket for lid   rubber



## Control lid

<b>1309677</b>	Control lid   plastic   2 inlets Ø 17 mm and 1 inlet Ø 14 mm   complete
<b>1307526</b>	Gasket for lid   rubber



## Control lid for aluminium buckets

<b>1309790</b>	Control lid   plastic   2 inlets Ø 12/17 mm   complete   for aluminium buckets
<b>1307525</b>	Gasket   for lid for aluminium bucket



## Control lid with non return valve

<b>1308720</b>	Control lid   non return valve   2 inlets Ø 16 mm
<b>1308723</b>	Non return valve



## Control lid blue and green

<b>1301810</b>	Control lid   plastic   blue   2 inlets Ø 16 x 20 mm   complete
<b>1309772</b>	Control lid   plastic   green   2 inlets Ø 16 x 20 mm   complete
<b>1307647</b>	Gasket for lid



## Libero lid

<b>1310539</b>	Libero lid   1 inlet Ø 14 x 19 mm   handle height 143 mm   complete
<b>1310540</b>	Libero lid   1 inlet Ø 16 x 21 mm   handle height 143 mm   complete
<b>1309905</b>	Gasket for lid   rubber
<b>1310735</b>	Hook



## Lid corr. Gascoigne Melotte

<b>1301402</b>	Lid   plastic   corr. Gascoigne Melotte D380.073
<b>1301177</b>	Gasket for lid   Ø 198 x 160 x 8 mm   green   corr. Gascoigne Melotte 299719



## Transport lid rubber

<b>1308704</b>	Transport lid   rubber   black   fits plastic and S/S buckets
----------------	---



## Gasket for lid DeLaval 20029

<b>1301176</b>	Gasket for lid   Ø 175 x 145 x 6 mm   corr. DeLaval 20029
----------------	---



## Gasket for lid corr. Fullwood 71305 M-12-W

<b>1301178</b>	Gasket for lid   Ø 220 x 173 x 8-12 mm   corr. Fullwood 71305 M-12-W
----------------	--



## Gasket for lid corr. Fullwood 71302 U-12-PL SS

**1300651** Gasket | Ø 221 x 180 x 6 mm | corr. Fullwood 71302 U-12-PL SS



## Gasket for lid corr. Westfalia 0007-3030-710

**1300617** Gasket for lid | Ø 198 x 164 x 6 mm | corr. Westfalia 0007-3030-710



## Rubber valve for vacuum tank

**1309848** Valve | rubber | for vacuum tank | corr. Fullwood



## Mini milker Friesland with S/S bucket for cow

**1307504** Mini milker Friesland | 1 S/S bucket | 1 milking cluster

**1310412** Mini milker Friesland | 1 S/S bucket | without milking cluster



## Mini milker Friesland galvanized with S/S bucket for COW

**1311350** Mini milker Friesland | galvanized | 1 S/S bucket | 1 milking cluster

**1311360** Mini milker Friesland | galvanized | 1 S/S bucket | without milking cluster



## Mini milker Friesland with plastic bucket for cow

**1314010** Mini milker Friesland | 1 plastic bucket | blue | 1 milking cluster

**1314023** Mini milker Friesland | 1 plastic bucket | green | 1 milking cluster

**1314020** Mini milker Friesland | 1 plastic bucket | red | 1 milking cluster

**1314012** Mini milker Friesland | 1 plastic bucket | blue | without milking cluster



## Mini milker Friesland galvanized plastic bucket for cow

<b>1311338</b>	Mini milker Friesland   galvanized   1 plastic bucket   blue   1 milking cluster
<b>1311333</b>	Mini milker Friesland   galvanized   1 plastic bucket   green   1 milking cluster
<b>1311370</b>	Mini milker Friesland   galvanized   1 plastic bucket   blue   without milking cluster



## Mini milker Friesland oil lubricated for cow

<b>1311320</b>	Mini milker Friesland   oil lubricated   1 S/S bucket   1 milking cluster
<b>1311430</b>	Mini milker Friesland   oil lubricated   1 plastic bucket   blue   1 milking cluster



## Mini milker Groningen S/S bucket for cow

<b>1301905</b>	Mini milker Groningen   1 S/S bucket   1 milking cluster
<b>1311098</b>	Mini milker Groningen   1 S/S bucket   without milking cluster



## Mini milker Groningen galvanized S/S bucket for cow

<b>1311328</b>	Mini milker Groningen   galvanized   1 S/S bucket   1 milking cluster
<b>1311334</b>	Mini milker Groningen   galvanized   1 plastic bucket   blue   1 milking cluster



## Mini milker Groningen plastic bucket for cow

<b>1314025</b>	Mini milker Groningen   1 plastic bucket   blue   1 milking cluster
<b>1314029</b>	Mini milker Groningen   1 plastic bucket   green   1 milking cluster
<b>1314026</b>	Mini milker Groningen   1 plastic bucket   blue   without milking cluster
<b>1314027</b>	Mini milker Groningen   1 plastic bucket   green   without milking cluster



## Mini milker Flevoland for cow

**1307515** Mini milker Flevoland | petrol engine | 1 S/S bucket | 1 milking cluster



## Mini milker Brabant for cow

**1307508** Mini milker Brabant | 500 ltr. at 50 kPa | 2 S/S buckets | 2 milking clusters



## Mini milker Holland for cow

**1307509** Mini milker Holland | petrol engine | 2 S/S buckets | 2 milking clusters



## Mini milker Moby for cow

**1312365** Mini milker Moby | oil lubricated | S/S bucket 25 ltr. | plastic lid

**1312355** Mini milker Moby | oil lubricated | plastic bucket 30 ltr. | plastic lid

**1310235** Mini milker Moby | S/S bucket 25 ltr. | plastic lid

**1310234** Mini milker Moby | plastic bucket 30 ltr. | plastic lid

**1310278** Vane | graphite | 70 x 42,9 x 5 mm

*Several parts on request*



## Parts for mini milkers for cow

**1314008** Milking cluster | complete | also for mini milkers and milk buckets

**1307519** Vacuum pump and electric motor | 200 ltr. | 1 hp | dry

**1307529** Vane | graphite | 65 x 45 x 4,8 mm | standard model for all mini milkers

**1307528** Vane | graphite | 70 x 45 x 4,8 mm

**1301010** Vacuum meter | dry | black | Ø 63 mm | ¼" BSP connection

**1311012** Silencer

**1310764** Shaft seal | for electric motor

**1310816** Condensator

**1308374** Switch

**1307530** Housing | for electro box

**1311335** Lid | for housing electro box

**1309906** Cap | square

**1307532** Cap | round | for frame mini milker Friesland

**1309831** Wheel | for mini milker Friesland





Chapter 11

# DRAIN- AND SOLENOID VALVES

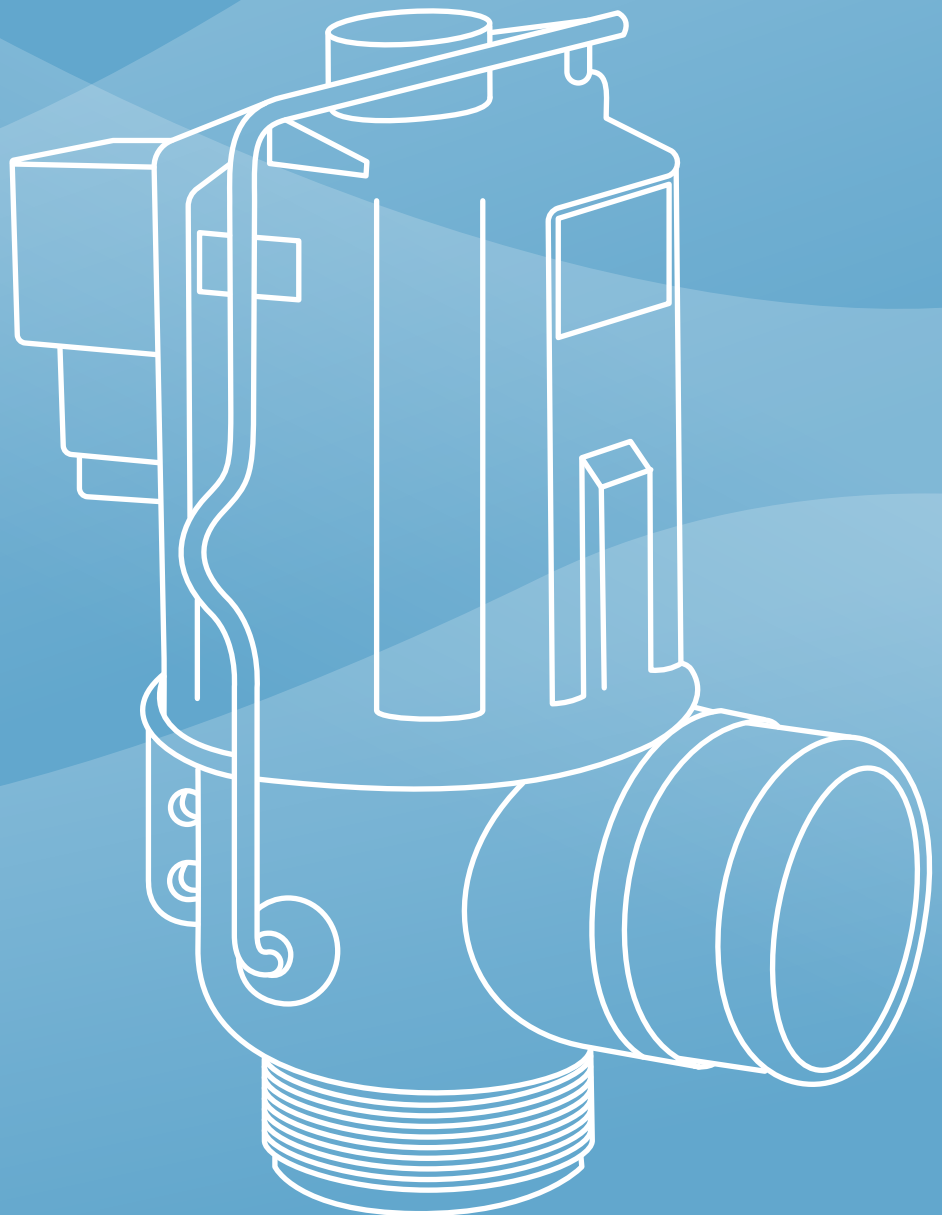



## Chapter 11 Drain- and solenoid valves

Drain valve	P160
Coil for drain valves	P160
Diaphragm for drain valves	P160
Drain valve 3-way, vacuum-controlled	P160
Drain valve corr. Surge	P161
Drain valve corr. Westfalia	P161
Drain valve corr. Miele	P161
Solenoid valve single, square	P161
Solenoid valve single, straight	P162
Solenoid valve double, square	P162
Solenoid valve double, straight	P162
Solenoid valve single, square with flow regulator	P162
Solenoid valve single, straight 17 mm throughput	P163
Solenoid valve single, straight ¾" x ¾" male thread	P163
Solenoid valve single, straight ½" x ½" male thread	P163
Solenoid valve with side-exit	P163
Solenoid valve with side-exit and cable	P163
Solenoid valve single, straight with PG11 plug	P163
Solenoid valve double, square with PG11 plug	P163
Solenoid valve double, square with cable	P164
Coils for solenoid valves	P164
Restrictors	P164
Parts for solenoid valves	P164
Solenoid valve corr. DeLaval	P164
Solenoid valve corr. Surge	P165
Solenoid valve single, straight	P165
Air valve single, square 2/2-way	P165
Air valve single, square 2/3-way	P165
Vacuum valve	P165
Magnetic valve	P165
Magnetic valve	P166

## Drain valve

<b>1312225</b>	Drain valve   nozzle/nozzle   DN40   200-240V   normally closed   splashwater protected
<b>1312185</b>	Drain valve   nozzle/nozzle   DN40   24V~   normally closed   splashwater protected
<b>1310142</b>	Drain valve   thread/nozzle   DN40   200-240V   normally closed   splashwater protected
<b>1312195</b>	Drain valve   nozzle/nozzle   DN40   200-240V   normally open   splashwater protected
<b>1310280</b>	Drain valve   nozzle/nozzle   DN50   200-240V   normally closed   splashwater protected
<b>1312190</b>	Drain valve   nozzle/nozzle   DN50   24V~   normally closed   splashwater protected
<i>All combinations are possible</i>	



## Coil for drain valves

<b>1310143</b>	Coil   DN40   200-240V   50-60Hz   normally closed
<b>1312197</b>	Coil   DN40   200-240V   50-60Hz   normally open
<b>1312187</b>	Coil   DN40   24V~AC
<b>1310299</b>	Coil   DN50   200-240V
<b>1312192</b>	Coil   DN50   24V~ AC



## Diaphragm for drain valves

<b>1301691</b>	Diaphragm   rubber   DN40
<b>1301692</b>	Diaphragm   rubber   DN50



## Drain valve 3-way, vacuum-controlled

<b>1310617</b>	Drain valve   3-way   vacuum-controlled   Ø 40 mm   normally closed
<b>1307751</b>	Diaphragm
<b>1330285</b>	Sealing disc
<b>1330284</b>	Lip joint
<b>1330282</b>	Joint
<b>1330286</b>	Set joints



## Drain valve corr. Surge

<b>1307757</b>	Drain valve   nozzle   2 x 50 mm   115V   50HZ   normally open   corr. Surge
<b>1307758</b>	Drain valve   nozzle   2 x 50 mm   115V   60HZ   normally open   corr. Surge
<b>1307759</b>	Drain valve   nozzle   2 x 50 mm   230V   50-60Hz   normally open   corr. Surge
<b>1307750</b>	Drain valve   nozzle   2 x 50 mm   230V   50-60Hz   normally closed   corr. Surge
<b>1307762</b>	Coil   220V



## Drain valve corr. Westfalia

<b>1311495</b>	Drain valve   2-way   Ø 40   vacuum-controlled   corr. Westfalia 7801-6780-020
<b>1311498</b>	Diaphragm   corr. Westfalia 7801-1702-020



## Drain valve corr. Miele

<b>1330206</b>	Drain valve   3-way   Ø 40   220 V   corr. Miele
----------------	--



## Solenoid valve single, square

<b>1301840</b>	Solenoid valve   single, square   220-240V   ½" nozzle   ¾" male thread
<b>1307738</b>	Solenoid valve   single, square   24V DC=   ½" nozzle   ¾" male thread
<b>1309754</b>	Solenoid valve   single, square   24V AC~   ½" nozzle   ¾" male thread
<b>1307739</b>	Solenoid valve   single, square   110-127V   ½" nozzle   ¾" male thread
<b>1309984</b>	Solenoid valve   single, square   220-240V   ⅜" nozzle   ¾" male thread



## Solenoid valve single, straight

<b>1301843</b>	Solenoid valve   single, straight   220-240V   ½" nozzle   ¾" male thread
<b>1307740</b>	Solenoid valve   single, straight   24V DC=   ½" nozzle   ¾" male thread
<b>1309755</b>	Solenoid valve   single, straight   24V AC~   ½" nozzle   ¾" male thread
<b>1307741</b>	Solenoid valve   single, straight   110-127V   ½" nozzle   ¾" male thread
<b>1309763</b>	Solenoid valve   single, straight   12V   ½" nozzle   ¾" male thread
<b>1309983</b>	Solenoid valve   single, straight   220-24V   ⅜" nozzle   ¾" male thread



## Solenoid valve double, square

<b>1301846</b>	Solenoid valve   double, square   220-240V   ½" nozzle   ¾" male thread
<b>1307742</b>	Solenoid valve   double, square   24V DC=   ½" nozzle   ¾" male thread
<b>1309756</b>	Solenoid valve   double, square   24V AC~   ½" nozzle   ¾" male thread
<b>1307743</b>	Solenoid valve   double, square   110-127V   ½" nozzle   ¾" male thread
<b>1309986</b>	Solenoid valve   double, square   220-240V   ⅜" nozzle   ¾" male thread



## Solenoid valve double, straight

<b>1301849</b>	Solenoid valve   double, straight   220-240V   ½" nozzle   ¾" male thread
<b>1307744</b>	Solenoid valve   double, straight   24V DC=   ½" nozzle   ¾" male thread
<b>1309757</b>	Solenoid valve   double, straight   24V AC~   ½" nozzle   ¾" male thread
<b>1307745</b>	Solenoid valve   double, straight   110-127V   ½" nozzle   ¾" male thread
<b>1309985</b>	Solenoid valve   double, straight   220-240V   ⅜" nozzle   ¾" male thread



## Solenoid valve single, square with flow regulator

<b>1330238</b>	Solenoid valve   single, square   220V   ½" nozzle   ¾" male thread   flow regulator
----------------	--



## Solenoid valve single, straight 17 mm throughput

<b>1330230</b>	Solenoid valve   single, straight   220V   21 mm nozzle   ¾" male thread   17 mm throughput
<b>1330235</b>	Solenoid valve   single, straight   24V DC=   21 mm nozzle   ¾" male thread   17 mm throughput



## Solenoid valve single, straight ¾" x ¾" male thread

<b>1312130</b>	Solenoid valve   single, straight   220V   ¾" x ¾" male thread
----------------	--



## Solenoid valve single, straight ½" x ½" male thread

<b>1330237</b>	Solenoid valve   single, straight   220V   ½" x ½" male thread
<b>1330231</b>	Solenoid valve   single, straight   24V DC   ½" x ½" male thread
<b>1330236</b>	Solenoid valve   single, straight   24V AC   ½" x ½" male thread
<b>1330239</b>	Solenoid valve   single, straight   12V AC   ½" x ½" male thread



## Solenoid valve with side-exit

<b>1330220</b>	Solenoid valve   220V   ¾" x ¾" male thread   side-exit ½" nozzle
----------------	---



## Solenoid valve with side-exit and cable

<b>1330225</b>	Solenoid valve   220V   ¾" x ¾" male thread   side-exit ½" nozzle   1 meter cable
----------------	---



## Solenoid valve single, straight with PG11 plug

<b>1330205</b>	Solenoid valve   single, straight   220V   ¾" x ¾" male thread   PG11 plug
----------------	--



## Solenoid valve double, square with PG11 plug

<b>1330210</b>	Solenoid valve   double, square   220V   ½" nozzle   ¾" male thread   PG11 plug
----------------	---



## Solenoid valve double, square with cable

<b>1330215</b>	Solenoid valve   double, square   220V   ½" nozzle   ¾" male thread   cable
----------------	---



## Coils for solenoid valves

<b>1301852</b>	Coil   220V-240V
<b>1307747</b>	Coil   24V DC=
<b>1307749</b>	Coil   24V AC~
<b>1307748</b>	Coil   110V-127V
<b>1330245</b>	Coil   220V   cable
<b>1330240</b>	Coil   220V   PG11 plug



## Restrictors

<b>1308297</b>	Restrictor   green   20 ltr./min.
<b>1330265</b>	Restrictor   violet   15 ltr./min.
<b>1308296</b>	Restrictor   grey   10 ltr./min.
<b>1330260</b>	Restrictor   black   8 ltr./min.
<b>1330255</b>	Restrictor   red   5 ltr./min.
<b>1330250</b>	Restrictor   green   2,5 ltr./min.
<b>1330248</b>	Restrictor   yellow   0,5 ltr./min.



## Parts for solenoid valves

<b>1308298</b>	Dirt catcher   white   connection/filter up
<b>1308353</b>	Dirt catcher   white   connection/filter down
<b>1309995</b>	Sieve   white   dirt catcher
<b>1307754</b>	Sieve   white   solenoid valves
<b>1330270</b>	Sieve   S/S   solenoid valves   ¾" male thread



## Solenoid valve corr. DeLaval

<b>1311035</b>	Solenoid valve   220-240V   ½" nozzle   corr. DeLaval 967.137-31
<b>1311048</b>	Solenoid valve   24V DC=   ½" nozzle   corr. DeLaval 967.137-81
<b>1311049</b>	Solenoid valve   24V AC~   ½" nozzle   corr. DeLaval 967.137-81



## Solenoid valve corr.Surge

<b>1307760</b>	Solenoid valve   double, square   120V   corr. Surge 32981
<b>1307761</b>	Coil   120V   corr. Surge 32686



## Solenoid valve single, straight

<b>1307766</b>	Solenoid valve   single, straight   3/2-way   220V   3/8" connection   normally open
<b>1307769</b>	Coil



## Air valve single, square 2/2-way

<b>1310145</b>	Air valve   single, square   2/2-way   220V   normally open   corr. Westfalia 7015-6780-310
<b>1307769</b>	Coil



## Air valve single, square 2/3-way

<b>1307767</b>	Air valve   single, square   2/3-way   220V   normally open   corr. Westfalia 7015-3780-200
<b>1307768</b>	Coil



## Vacuum valve

<b>1307764</b>	Vacuum valve   12W-12V DC   corr. Miele
<b>1307765</b>	Coil   12W-12V DC
<b>1330012</b>	Set sliding foils



## Magnetic valve

<b>0404098</b>	Magnetic valve   3/8"   type HK   normally closed
<b>0404099</b>	Magnetic valve   1/2"   type HK   normally closed
<b>0404100</b>	Magnetic valve   3/4"   type HK   normally closed
<b>0404101</b>	Magnetic valve   1"   type HK   normally closed



## Magnetic valve

<b>0404069</b>	Magnetic valve   ½"   type WKB   normally closed
<b>0404070</b>	Magnetic valve   ¾"   type WKB   normally closed
<b>0404071</b>	Magnetic valve   1"   type WKB   normally closed
<b>0404073</b>	Magnetic valve   1½"   type WKB   normally closed





Chapter 12

# CLEANING AND HYGIENE

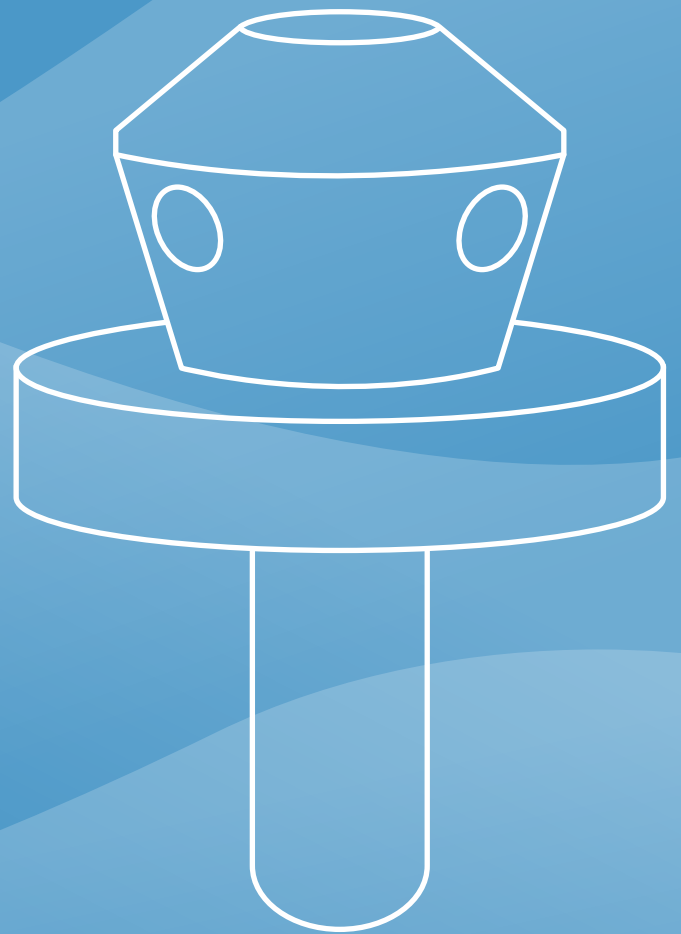
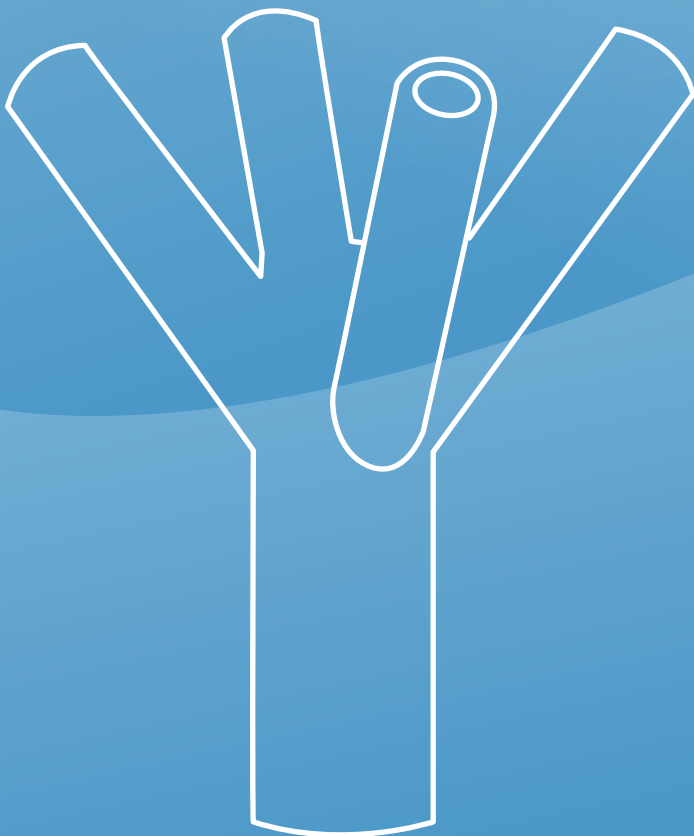

## Chapter 12 Cleaning and hygiene

Inflation sprayer Ø 20 mm yellow	P170
Inflation sprayer Ø 22 mm yellow	P170
Inflation sprayer corr. Westfalia/Fullwood	P170
Inflation sprayer type 2	P170
Inflation sprayer Ø 26 mm orange	P170
Distributor black	P170
Distributor blue	P171
Distributor thick model	P171
Reduction for distributors	P171
S/S distributor	P171
S/S distributor with side-connection	P171
Jettercup corr. Boumatic	P171
Jettercup corr. DeLaval	P171
Jettercup corr. DeLaval blue	P172
Jettercup corr. Fullwood	P172
Jettercup corr. Gascoigne Melotte	P172
Jettercup corr. Manus	P172
Jettercup corr. Milkrite	P172
Jettercup corr. Surge	P172
Jettercup corr. Hy Jet 10	P172
Jettercup	P173
Washing unit corr. DeLaval	P173
Washing unit collapsible	P173
Sprayer	P173
Washing unit plastic pipe connection	P174
Washing unit with jettors	P174
Washing unit long nozzles	P174
Washing unit	P174
Washing unit S/S	P174
Washing unit M-Tec	P174
Cup corr. Lely	P175
Plastic sink	P175
S/S sink	P175
Heater corr. Westfalia	P175
Heater corr. DeLaval	P175
Udder sprayer Gilmour	P176
Udder sprayer max. 80°C	P176
Udder sprayer	P176

RP power spray gun	P176
Spray gun Nedlac	P176
Nedlac High Flow spray gun incl. tube	P176
Spray gun	P177
Udder sprayer	P177
Flexible udder sprayer	P177
Side dipper	P177
Top dipper	P177
Teat dipper	P177
Multi foamer	P177
EasiFoamer	P178
Manual sprayer 500 CC	P178
Ambic ATS 400	P178
Ambic JetStream 2000	P178
Pre milking cup	P178
Ambic mastitis detector	P179
Quarter milker	P179
Dosing pump	P179
Dosing pump corr. Fullwood	P179
Dosing pump corr. Westfalia	P179
Tube for dosing pump	P180
Cleaner tube	P180
Diaphragm corr. Dairymaster	P180
Diaphragm corr. DeLaval	P180
Control valve corr. DeLaval	P180
Pressure switch corr. DeLaval	P180
Gasket corr. DeLaval	P181
Parts corr. Westfalia Circomat	P181
Scrub brush	P181
Brush for milk tube	P181
Brush for milk claws	P181
Brush Ø 30/50 mm	P181
Brush Ø 80 x 120 mm	P181
Brush for liner 40 x 300 mm	P182
Brush for liner	P182
Turn brush	P182
Hand scrub brush	P182
Flexible scrub brush	P182
Brush for corners	P182
Brush complete	P182

Brush corr. Fullwood	P183
Brush corr. Lely	P183
Apron	P183
Milking gloves	P183
Cleaning paper	P183
Hand cleaner	P183
Washing machine tube	P184
Water tube EPDM	P184
Water tube Trix	P184
Mega washdownsystem	P184
Milking cluster cleaner	P184
Sponge	P185
Floor squeegee	P185
Manure strip	P185

## Inflation sprayer Ø 20 mm yellow

<b>1301703</b>	Inflation sprayer   Ø 20 mm   yellow
----------------	--------------------------------------



## Inflation sprayer Ø 22 mm yellow

<b>1307090</b>	Inflation sprayer   Ø 22 mm   yellow   also for silicone liners corr. Westfalia
----------------	---

<b>1307095</b>	Inflation sprayer   Ø 22 mm   blue   also for silicone liners corr. Westfalia
----------------	---

<b>1307096</b>	Inflation sprayer   Ø 22 mm   green   also for silicone liners corr. Westfalia
----------------	--

<b>1307097</b>	Inflation sprayer   Ø 22 mm   black   also for silicone liners corr. Westfalia
----------------	--



## Inflation sprayer corr. Westfalia/Fullwood

<b>1307088</b>	Inflation sprayer   Ø 24 mm   blue   corr. Westfalia/Fullwood
----------------	---

<b>1301356</b>	Inflation sprayer   Ø 24 mm   green   corr. Westfalia/Fullwood
----------------	--

<b>1301355</b>	Inflation sprayer   Ø 24 mm   black   corr. Westfalia/Fullwood
----------------	--



## Inflation sprayer type 2

<b>1307092</b>	Inflation sprayer   Ø 23 mm   blue
----------------	------------------------------------

<b>1307091</b>	Inflation sprayer   Ø 23 mm   orange
----------------	--------------------------------------

<b>1307098</b>	Inflation sprayer   Ø 24 mm   black
----------------	-------------------------------------

<b>1307099</b>	Inflation sprayer   Ø 24 mm   green
----------------	-------------------------------------



## Inflation sprayer Ø 26 mm orange

<b>1307089</b>	Inflation sprayer   Ø 26 mm   orange
----------------	--------------------------------------



## Distributor black

<b>1301302</b>	Distributor   with hole   Ø 6,9 x 9,9 mm and Ø 13 x 17,5 mm   black
----------------	---

<b>1301301</b>	Distributor   without hole   Ø 6,9 x 9,9 mm and Ø 13 x 17,5 mm   black
----------------	--



## Distributor blue

<b>1308163</b>	Distributor   with hole   Ø 6,9 x 9,9 mm and Ø 13 x 17,5 mm   blue
<b>1308164</b>	Distributor   without hole   Ø 6,9 x 9,9 mm and Ø 13 x 17,5 mm   blue



## Distributor thick model

<b>1310498</b>	Distributor   with hole   Ø 8,7 x 11,8 mm and Ø 12 x 16,1 mm   black
<b>1310499</b>	Distributor   without hole   Ø 8,7 x 11,8 mm and Ø 12 x 16,1 mm   black



## Reduction for distributors

<b>1301303</b>	Reduction   for distributor   Ø 12,4 x 10,3 mm   corr. Gascoigne Melotte D240.727
----------------	---



## S/S distributor

<b>1309551</b>	Distributor   S/S   without hole   Ø 16 x 9,5 mm outside
----------------	--



## S/S distributor with side-connection

<b>1309552</b>	Distributor   S/S   side-connection   Ø 7,9 x 15,7 mm inside
----------------	--



## Jettercup corr. Boumatic

<b>1312085</b>	Jettercup   Ø 50 mm   rubber   corr. Boumatic 8503023
----------------	---



## Jettercup corr. DeLaval

<b>1310362</b>	Jettercup   Ø 69 mm   rubber   corr. DeLaval 966.745-80
<b>1301347</b>	Jettercup   Ø 60/52 mm   rubber   corr. DeLaval 7271362



## Jettercup corr. DeLaval blue

<b>1330121</b>	Jettercup   Ø 56,25 mm   blue   corr. DeLaval 964.346-01
<b>1330124</b>	Jettercup   Ø 64,5 mm   blue   corr. DeLaval 966.398-01



## Jettercup corr. Fullwood

<b>1308221</b>	Jettercup   Ø 43 mm   short model   corr. Fullwood
----------------	--



## Jettercup corr. Gascoigne Melotte

<b>1310379</b>	Jettercup   Ø 62 mm   rubber   corr. Gascoigne Melotte 381.354
<b>1301346</b>	Jettercup   Ø 60 mm   rubber   corr. Gascoigne Melotte 381.112
<b>1301348</b>	Jettercup   Ø 55 mm   rubber   corr. Gascoigne Melotte 381.353
<b>1301349</b>	Jettercup   Ø 45 mm   rubber   corr. Gascoigne Melotte MK2
<b>1307441</b>	Jettercup   Ø 38 mm   rubber   corr. Gascoigne Melotte MK1



## Jettercup corr. Manus

<b>1309949</b>	Jettercup   Ø 55 mm   rubber   corr. Manus 966.077-01
<b>1310591</b>	Jettercup   Ø 52 mm   rubber   corr. Manus 966.077



## Jettercup corr. Milkrite

<b>1312695</b>	Jettercup   corr. Milkrite EU39XZ
<b>1312696</b>	S/S plate for jettercup corr. Milkrite



## Jettercup corr. Surge

<b>1308220</b>	Jettercup   Ø 52 mm   rubber   short model   corr. Surge 21136
<b>1308222</b>	Tube   for jettercup   corr. Surge 21592



## Jettercup corr. Hy Jet 10

<b>1309809</b>	Jettercup   Ø 44 mm   rubber   corr. Hy Jet 10
----------------	--



## Jettercup

**1309769** Jettercup | Ø 30 mm | rubber | universal



## Washing unit corr. DeLaval

**1316480** Washing unit | with candles | corr. DeLaval 905.086-83

**1316550** Repair kit | corr. DeLaval 907.430-83

**1316484** Bridge | corr. DeLaval 999.410-80

**1311675** Jettercup | high | rubber | corr. DeLaval 907.429-01

**1309958** Cupring | high model | rubber | corr. DeLaval 999.413-02

**1310363** Cupring | high model | silicone | corr. DeLaval 35227

**1311063** Cupring | low model | corr. DeLaval 999.413-02 and Manus 966077

**1311670** Candle | blue | corr. DeLaval 905.086-01

**1311660** Candle | white | corr. DeLaval 905.086-01

**1311672** Threaded holder | white | corr. DeLaval 908.085-01

**1311674** Ring | corr. DeLaval 905.087-01

**1316487** Joint



## Washing unit collapsible

**1306979** Washing unit | collapsible | connection right

**1306978** Washing unit | collapsible | connection left

**1306977** Cupring

**1306976** Diaphragm

**1306974** Housing | plastic

**1306975** Sprayer



## Sprayer

**1306980** Sprayer | blue | corr. Lely A2 and DeLaval

**1306990** Cupring | corr. Lely A2

**1306995** Set cupring and sprayer | corr. Lely A2

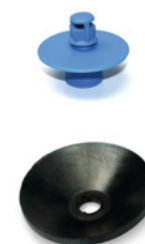



## Washing unit plastic pipe connection

**1301334** Washing unit | plastic | rubber jettercups | Ø 38 mm pipe connection



## Washing unit with jettors

**1301314** Washing unit | plastic | jettors Ø 23 mm | Ø 16 mm tube connection



## Washing unit long nozzles

**1301328** Washing unit | plastic | long nozzles | Ø 38 mm pipe connection

**1301332** Washing unit | plastic | long nozzles | Ø 16 mm tube connection



## Washing unit

**1301307** Washing unit | 1¼" wall connection | not collapsible | without jettors

**1301304** Washing unit | 1¼" tube connection | collapsible | without jettors

**1301306** Washing unit | 1¼" tube connection | not collapsible | without jettors

**1301308** Jettors | Ø 29 mm | blue | set of 4 pieces

**1301309** Jettors | Ø 32 mm | black | set of 4 pieces



## Washing unit S/S

**1301341** Washing unit | S/S | 1" wall or tube connection



## Washing unit M-Tec

**1330040** Washing unit | M-Tec | S/S | collapsible | 360° adjustable

**1334002** Connection knee

*The separate spare parts are also available*



## Cup corr. Lely

**1308150** Cup | silicone | red | corr. Lely



## Plastic sink

**1310997** Sink | plastic | single | 100 ltr. | 990 x 280 x 590 mm | without wall supports

**1307776** Sink | plastic | single | 60 ltr. | 720 x 350 x 590 mm | without wall supports

**1310998** Set wall supports | for plastic sink 100 ltr.

**1307777** Set wall supports | for plastic sink 60 ltr.



## S/S sink

**1307774** Sink | S/S | single | 130 ltr. | 1080 x 320 x 525 mm

**1307773** Sink | S/S | single | 100 ltr. | 860 x 320 x 525 mm

**1307772** Sink | S/S | single | 70 ltr. | 625 x 320 x 525 mm

**1307771** Sink | S/S | single | 50 ltr. | 460 x 320 x 525 mm

**1307780** Set wall supports | S/S sinks

**1307778** Outlet | S/S | Ø 38 mm (1½")

**1307779** Stop | rubber



## Heater corr. Westfalia

**1316245** Heater | 3000 watt | corr. Westfalia



## Heater corr. DeLaval

**1316250** Heater | 5000 watt | 400V | with cable | corr. DeLaval C100-C200-T100-T150-T200-T250

**1316240** Heater | 3000/5000 watt | corr. DeLaval Alwa 996.957-01

**1316242** Heater | corr. DeLaval C200 905.176-07



## Udder sprayer Gilmour

<b>1308039</b>	Udder sprayer   Gilmour 572 TFRE   red   heavy model   ¾" connection
<b>1301052</b>	Udder sprayer   Gilmour 571E   green   ¾" connection



## Udder sprayer max. 80°C

<b>1301864</b>	Udder sprayer   blue   ¾" connection   max. 80°C
<b>1301953</b>	Udder sprayer   yellow   ¾" connection   max. 80°C



## Udder sprayer

<b>1301865</b>	Udder sprayer   blue   ¾" connection   6 stands
----------------	---



## RP power spray gun

<b>1309701</b>	RP power spray gun   1" nozzle
<b>1310804</b>	Ring   plastic
<b>1310805</b>	O-ring   large
<b>1310806</b>	O-ring   small
<b>1310807</b>	Joint   Ø 4 mm



## Spray gun Nedlac

<b>1301683</b>	Nedlac High Flow   high volume spray gun   1" nozzle
<b>1309872</b>	Repair kit
<b>1309928</b>	O-ring   Ø 28,17 x 3,53 mm
<b>1309929</b>	O-ring   for 1" tube



## Nedlac High Flow spray gun incl. tube

<b>1310985</b>	Nedlac High Flow spray gun   with 25 mtr. 1" tube
----------------	---



## Spray gun

7010811 Spray gun | blue | ½" female thread | EPDM cover



## Udder sprayer

1301040 Udder sprayer | black | ½" connection



## Flexible udder sprayer

1301056 Udder sprayer | flexible | ¾" | large model | corr. Westfalia

1301054 Udder sprayer | flexible | black | ½" nozzle



## Side dipper

1301015 Side dipper | non-return valve | blue

1309796 Side dipper | non-return valve | yellow



## Top dipper

1309794 Top dipper | non-return valve | yellow



## Teat dipper

1301077 Teat dipper | without non-return valve | blue

1301078 Teat dipper | with non-return valve | blue



## Multi foamer

1310908 Multi foamer | Ambic TM PLUS



## EasiFoamer

**1310099** EasiFoamer | 1 connection | Ambic



## Manual sprayer 500 CC

**1301044** Manual sprayer | S/S nozzle

**1307693** Bottle | plastic

**1301045** Trigger and S/S nozzle

**1334007** S/S nozzle | new model



## Ambic ATS 400

**1310090** Classic dip spray system | ATS 400 | 3 spray guns | vacuum operated

**1308698** Diaphragm pump | complete

**1308706** Valve | complete



## Ambic JetStream 2000

**1310095** JetStream 2000 | Ambic | 3 spray guns | vacuum operated

**1310098** Extension set | 1 spray gun | new model

**1308707** Spray gun | button | new model

**1308709** Spray gun | handle | old model

**1308700** Diaphragm pump | complete

**1308706** Valve | complete

**1310096** Repair kit

**1310092** Spiral hose | blue

**1308710** T-piece | hose connector

**1308712** Hose connector | straight | set of 2 pieces

**1308715** PVC tube Ø 7 x 10 mm, 30 mtr/coil



## Pre milking cup

**1308701** Pre milking cup | blue

**1308702** Pre milking cup | green



## Ambic mastitis detector

<b>1308694</b>	Ambic Vision 2000   mastitis detector   Ø 16 mm
<b>1310695</b>	Ambic Vision 2000   mastitis detector   Ø 16 mm   set of 4 pieces
<b>1310697</b>	Sieve   set of 2 pieces
<b>1310693</b>	Body   only
<b>1308695</b>	O-rings   set of 6 pieces



## Quarter milker

<b>1301058</b>	Quarter milker   plastic   8 ltr.   with handle
<b>1301062</b>	Lid   complete
<b>1301061</b>	Gasket for lid   Ø 79 x 104 x 3 mm
<b>1301063</b>	Float ball
<b>1301060</b>	O-ring   rubber   Ø 70 x 5 mm
<b>1301065</b>	Milk tube   Ø 9,5 x 18,5 x 550 mm
<b>1301064</b>	Vacuum tube   Ø 8 x 16 x 550 mm
<b>1301059</b>	Tube connector   Ø 10 mm



## Dosing pump

<b>1340283</b>	Dosing pump   12V   corr. Wedhold and DeLaval 905.590-02
<b>1340288</b>	Dosing pump   24V= DC   for milking robot   corr. DeLaval
<b>1340289</b>	Tube   silicone   corr. DeLaval



## Dosing pump corr. Fullwood

<b>1340509</b>	Dosing pump   24V   1642 ml/min.   corr. Fullwood M1500
----------------	---



## Dosing pump corr. Westfalia

<b>1340281</b>	Dosing pump   230V   420 ml/min   corr. Westfalia 3300-0223-483
<b>1340279</b>	Housing   corr. Westfalia



## Tube for dosing pump

<b>1340490</b>	Tube   for dosing pump   corr. Boumatic Guardian 8507719
<b>1340492</b>	Tube   for dosing pump   corr. Westfalia Varioteh 7015-6638-250/210
<b>1340493</b>	Tube   for dosing pump   Ø 6,4 x 9,6 x 1,6 mm
<b>1340494</b>	Tube   for dosing pump   Ø 6,4 x 11,2 x 2,4 mm
<b>1340495</b>	Tube   for dosing pump   Ø 8 x 11,2 x 1,6 mm
<b>1340496</b>	Tube   for dosing pump   Ø 6,2 x 10,5 x 2,15 mm
<i>Available per meter.</i>	



## Cleaner tube

<b>1340505</b>	Cleaner tube   red   Ø 6 mm   50 mtr./coil
<b>1340507</b>	Cleaner tube   blue   Ø 6 mm   50 mtr./coil



## Diaphragm corr. Dairymaster

<b>1316258</b>	Diaphragm   for drain valve   corr. Dairymaster Jetstream JS17 and RJ09
----------------	---



## Diaphragm corr. DeLaval

<b>1340511</b>	Diaphragm   corr. DeLaval C200 830.725-406
<b>1340513</b>	Diaphragm   corr. DeLaval VMS 959.275-02



## Control valve corr. DeLaval

<b>1340517</b>	Control valve   230V   100% ED   corr. DeLaval
----------------	--



## Pressure switch corr. DeLaval

<b>1340519</b>	Pressure switch   corr. DeLaval Pressostat 00717100
----------------	---



## Gasket corr. DeLaval

**1340523** Gasket | for holder cleaner | corr. DeLaval/Alwa 997.986-01

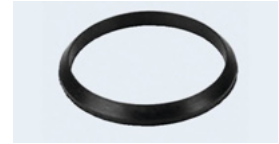

## Parts corr. Westfalia Circomat

**1340515** Diaphragm | corr. Westfalia Circomat 0004-3070-820

**1340521** Spring | corr. Westfalia Circomat 0006-4046-300



## Scrub brush

**1311274** Scrub brush | handle | 290 x 45 mm

**1311272** Scrub brush | handle | 400 x 48 mm



## Brush for milk tube

**1309585** Brush | for milk tube | Ø 10 mm x 400 mm

**1309589** Brush | for milk tube | Ø 15 mm x 1000 mm

**1309590** Brush | for milk tube | Ø 15 mm x 1500 mm

**1309591** Brush | for milk tube | Ø 15 mm x 2000 mm



## Brush for milk claws

**1311258** Brush | for milk claws



## Brush Ø 30/50 mm

**1309588** Brush | Ø 30/50 mm x 400 mm



## Brush Ø 80 x 120 mm

**1311260** Brush | Ø 80 x 120 mm | length 600 mm

**1311262** Brush | Ø 80 x 120 mm | length 2500 mm





## Brush for liner 40 x 300 mm

**1309586** Brush | for liners | Ø 40 x 300 mm



## Brush for liner

**1309587** Brush | for liner head Ø 30/50 mm



## Turn brush

**1309592** Turn brush | short

**1309593** Turn brush | long



## Hand scrub brush

**1311268** Hand scrub brush | 210 x 72 mm



## Flexible scrub brush

**1311270** Scrub brush | flexible | 165 x 70 mm



## Brush for corners

**1311276** Brush | for corners | 230 x 85 mm

**1311278** Brush | round model | Ø 120 mm

**1311280** Handle | aluminium | 1450 mm



## Brush complete

**1311265** Brush | complete | for cooling installation

**1311264** Brush | only

**1311266** Handle | only



## Brush corr. Fullwood

<b>1311580</b>	Brush   125 mm length   blue/white   corr. Fullwood M2
<b>1311585</b>	Brush   160 mm length   blue/white   corr. Fullwood MK1, 2007, 225, MK4



## Brush corr. Lely

<b>1311560</b>	Brush   orange/white   corr. Lely 222157 A3/A4 no. 5
----------------	--



## Apron

<b>1309858</b>	Apron   green
<b>1309765</b>	Apron   blue



## Milking gloves

<b>1309841</b>	Milking gloves   nitrile   Xlarge   100 pieces
<b>1309840</b>	Milking gloves   nitrile   Large   100 pieces
<b>1309839</b>	Milking gloves   nitrile   Medium   100 pieces
<b>1309838</b>	Milking gloves   nitrile   Small   100 pieces



## Cleaning paper

<b>0050021</b>	Cleaning paper   Dreumex   1000 mtr.
----------------	--------------------------------------



## Hand cleaner

<b>0050006</b>	Hand cleaner   Dreumex   "Special"   4,2 kg <i>An alkaline and solvent-free hand cleaner with skin-friendly micro grain. Rich foamy and pleasantly perfumed.</i>
<b>0050003</b>	Hand cleaner   Dreumex   "Classic"   4½ ltr. <i>Gel-shaped hand cleanser with a skin-friendly micro-grit for increased and better cleaning action.</i>
<b>0050007</b>	Hand cleaner   Dreumex   "Plus"   4½ ltr. <i>Extra powerful hand cleaner for removing the heaviest pollution.</i>
<b>0050009</b>	Dispenser   for 4½ ltr. bucket



## Washing machine tube

<b>1301693</b>	Washing machine tube   1,5 meter   ¾" connection   max. 95°C   60 bar
<b>1301697</b>	Washing machine tube   2,5 meter   ¾" connection   max. 95°C   60 bar
<b>1301694</b>	Joint



## Water tube EPDM

<b>0502356</b>	EPDM water tube   type Jumbo   13 x 19 x 3 mm   15 bar   40 mtr/coil
<b>0502357</b>	EPDM water tube   type Jumbo   19 x 27 x 4 mm   15 bar   40 mtr/coil
<b>0502358</b>	EPDM water tube   type Jumbo   25 x 37 x 6 mm   15 bar   40 mtr/coil



## Water tube Trix

<b>1340470</b>	Trix water tube   13 x 19 mm   20 bar   40 mtr/coil
<b>1340472</b>	Trix water tube   19 x 27 mm   20 bar   40 mtr/coil
<b>1340476</b>	Trix water tube   25 x 34 mm   20 bar   40 mtr/coil
<b>1340478</b>	Trix water tube   32 x 43 mm   20 bar   40 mtr/coil



## Mega washdownsystem

<b>1310960</b>	Washdownsystem   Mega   complete
----------------	----------------------------------



## Milking cluster cleaner

<b>1308002</b>	Milking cluster cleaner   boiling water version   complete
<b>1308325</b>	Cylinder   transparant
<b>1308151</b>	Float
<b>1308705</b>	Sealkit   set of 2 pieces



## Sponge

<b>1307424</b>	Sponge		50 x 50 mm		for tube Ø 32-40 mm (1¼"-1½")
<b>1307425</b>	Sponge		60 x 70 mm		for tube Ø 50 mm (2")
<b>1307426</b>	Sponge		70 x 70 mm		for tube Ø 63 mm (2½")
<b>1311014</b>	Sponge		90 x 95 mm		for tube Ø 76 mm (3")
<b>1310436</b>	Sponge		110 x 100 mm		for tube Ø 100 mm (4")



## Floor squeegee

<b>1301079</b>	Floor squeegee		reinforced		45 cm
<b>1301080</b>	Floor squeegee		reinforced		55 cm
<b>1301081</b>	Floor squeegee		reinforced		75 cm



## Manure strip

<b>1307415</b>	Manure strip		manure robot		corr. Lely Discovery
----------------	--------------	--	--------------	--	----------------------





Chapter 13

# MILKING PARLOR EQUIPMENT

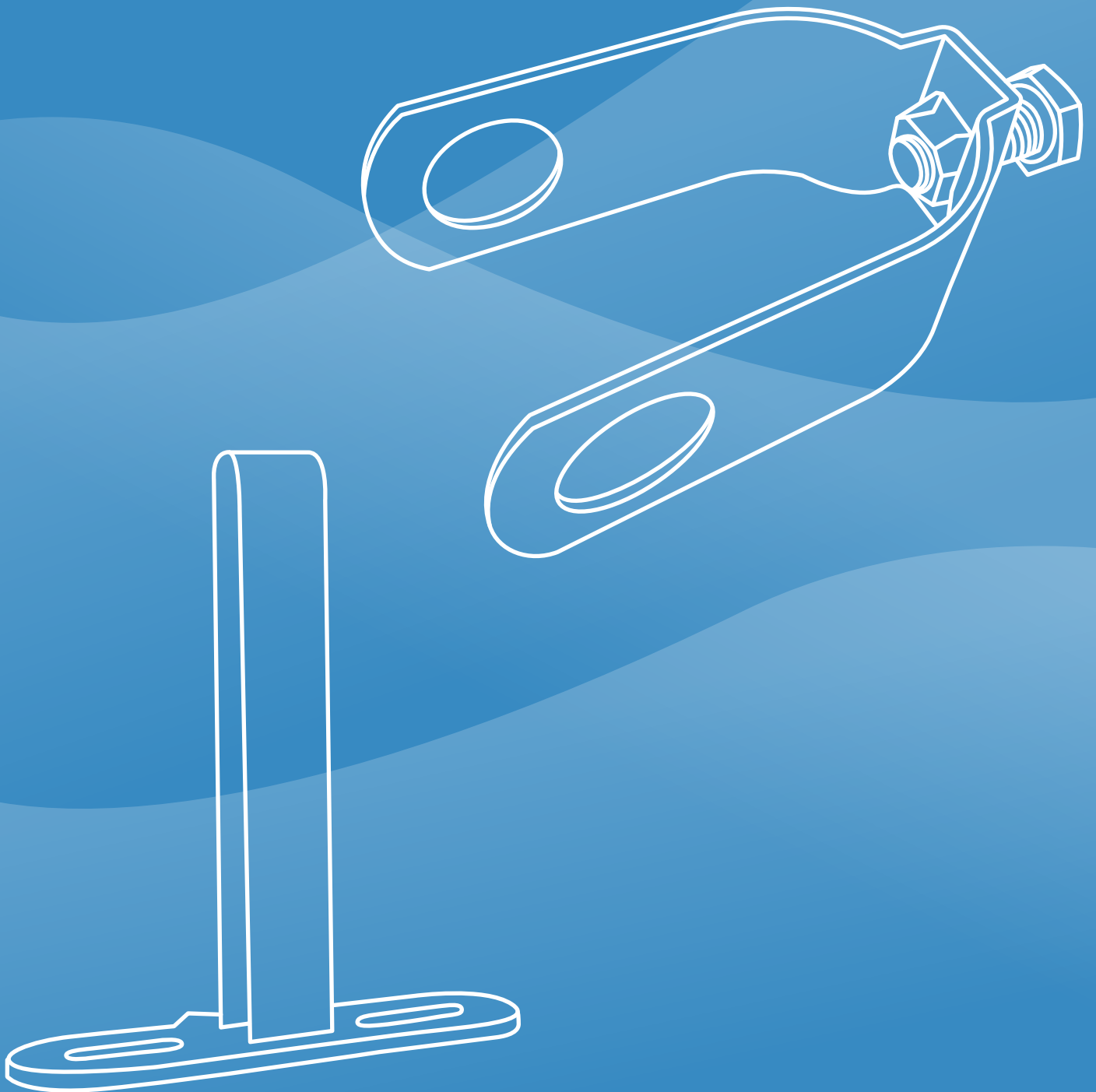

# Chapter 13 Milking parlor equipment

Wall bracket S/S	P189
Wall bracket hot dipped galvanized	P189
Sliding bracket S/S	P189
Sliding bracket hot dipped galvanized	P189
Support slide	P189
S/S clamp	P190
Tube clamp "Easy Click"	P190
Tube clamp	P190
Tube clamp with ½" thread	P190
Parts for tube clamps	P191
Cross clamp casted	P191
Overcross clamp	P191
Cross clamp	P191
T-clamp 90°	P192
Tube crossing	P192
Pipe support	P192
U-bracket hot dipped galvanized	P193
U-bracket electrolytically galvanized	P193
Threaded clamp	P194
Double spacer bracket	P194
Counter plate	P194
S/S snap hooks	P194
Plastic snap hooks	P195
Pulley	P195
Sleeve	P195
Pipe coupling	P195
Non-kick bar	P195
Cable bundle straps	P195
Cable bundle straps natural	P196
S/S hose clamp, entirely S/S	P196
Trough	P196
Dosing motor corr. GEA	P196
Dosing motor corr. Nedap/GEA/Miele/Lely/Manus/SAC	P197
Auger	P197
Parts for auger	P197
Spring	P197
Crouzet motor	P197
Drive motor	P198

Parts for Crouzet motor	P198
Capacitor	P198
Cow identification straps	P198
Cow identification straps velcro	P198
Ruminal magnet	P198
Cow ID curtain corr. DeLaval 984.523-80	P199
Manure strip corr. Lely Discovery	P199
Teat cup cord corr. Lely A3/A4/A5	P199



## Wall bracket S/S

1301437	Wall bracket   S/S   ½"
---------	-------------------------



## Wall bracket hot dipped galvanized

1301436	Wall bracket   hot dipped galvanized   ½"
---------	---

1307898	Wall bracket   hot dipped galvanized   ¾"
---------	---

1301439	Wall bracket   hot dipped galvanized   1"
---------	---

1301443	Wall bracket   hot dipped galvanized   1¼"
---------	--

1301441	Wall bracket   hot dipped galvanized   1½"
---------	--



## Sliding bracket S/S

1301512	Sliding bracket   S/S   15 cm
---------	-------------------------------

1301518	Sliding bracket   S/S   25 cm
---------	-------------------------------

1301521	Sliding bracket   S/S   30 cm
---------	-------------------------------

1301524	Sliding bracket   S/S   40 cm
---------	-------------------------------



## Sliding bracket hot dipped galvanized

1301511	Sliding bracket   hot dipped galvanized   15 cm
---------	---

1301514	Sliding bracket   hot dipped galvanized   20 cm
---------	---

1301517	Sliding bracket   hot dipped galvanized   25 cm
---------	---

1301520	Sliding bracket   hot dipped galvanized   30 cm
---------	---

1301523	Sliding bracket   hot dipped galvanized   40 cm
---------	---

1301526	Sliding bracket   hot dipped galvanized   50 cm
---------	---

1301529	Sliding bracket   hot dipped galvanized   60 cm
---------	---



## Support slide

1301642	Support slide   S/S   horizontal   300 mm
---------	---

1301640	Support slide   S/S   vertical   400 mm
---------	---

1301641	Support slide   S/S   vertical   600 mm
---------	---



## S/S clamp

<b>1301643</b>	Clamp   S/S   32-50 mm
<b>1301644</b>	Clamp   S/S   50-70 mm
<b>1301645</b>	Clamp   S/S   60-80 mm
<b>1301646</b>	Clamp   S/S   80-100 mm
<b>1301647</b>	Plate   S/S   only



## Tube clamp "Easy Click"

<b>1309425</b>	Tube clamp   plastic   "Easy Click"   Ø 25 mm   without clip
<b>1309432</b>	Tube clamp   plastic   "Easy Click"   Ø 32 mm   without clip
<b>1309440</b>	Tube clamp   plastic   "Easy Click"   Ø 40 mm
<b>1309450</b>	Tube clamp   plastic   "Easy Click"   Ø 50 mm
<b>1309463</b>	Tube clamp   plastic   "Easy Click"   Ø 63 mm
<b>1309475</b>	Tube clamp   plastic   "Easy Click"   Ø 75 mm
<b>1309490</b>	Tube clamp   plastic   "Easy Click"   Ø 90 mm



## Tube clamp

<b>0110950</b>	Tube clamp   plastic   Ø 16 mm   without clip
<b>0110951</b>	Tube clamp   plastic   Ø 20 mm   without clip
<b>0110952</b>	Tube clamp   plastic   Ø 25 mm   without clip
<b>0110953</b>	Tube clamp   plastic   Ø 32 mm   without clip
<b>0110954</b>	Tube clamp   plastic   Ø 40 mm
<b>0110955</b>	Tube clamp   plastic   Ø 50 mm
<b>0110956</b>	Tube clamp   plastic   Ø 63 mm
<b>0110957</b>	Tube clamp   plastic   Ø 75 mm
<b>0110958</b>	Tube clamp   plastic   Ø 90 mm
<b>0110959</b>	Tube clamp   plastic   Ø 110 mm



## Tube clamp with ½" thread

<b>1301580</b>	Tube clamp   black   1"
<b>1301581</b>	Tube clamp   black   1½"
<b>1301582</b>	Tube clamp   black   2"
<b>1301583</b>	Tube clamp   black   2½"
<b>1301584</b>	Tube clamp   black   3"



## Parts for tube clamps

<b>1301587</b>	Rubber section   29 x 34 x 3 mm   5 mtr/coil
<b>1301592</b>	Double distance bracket   h-h 90 mm   plastic   incl. bolt and nut   corr. Gascoigne Melotte
<b>1307035</b>	Tube holder   black   with thread
<b>1301586</b>	Screw   S/S   A2 cross head   25 x 6,3 mm   blunt point



## Cross clamp casted

<b>1301605</b>	Cross clamp   casted   1" x 1"
<b>1301606</b>	Cross clamp   casted   1" x 1¼"
<b>1301607</b>	Cross clamp   casted   1¼" x 1¼"
<b>1301608</b>	Cross clamp   casted   1½" x 1"
<b>1301609</b>	Cross clamp   casted   1½" x 1¼"
<b>1301610</b>	Cross clamp   casted   1½" x 1½"
<b>1301611</b>	Cross clamp   casted   2" x 1"
<b>1301612</b>	Cross clamp   casted   2" x 1¼"
<b>1301613</b>	Cross clamp   casted   2" x 1½"
<b>1301702</b>	Cross clamp   casted   2" x 2"



## Overcross clamp

<b>1307910</b>	Overcross clamp   hot dipped galvanized   M10 x 25 mm   1½" x 1½"
<b>1307911</b>	Overcross clamp   hot dipped galvanized   M10 x 25 mm   2" x 1½"
<b>1307912</b>	Overcross clamp   hot dipped galvanized   M10 x 25 mm   2" x 2"



## Cross clamp

<b>1309521</b>	Cross clamp   wide   hot dipped galvanized   1¼" x 1¼"
<b>1309522</b>	Cross clamp   wide   hot dipped galvanized   1½" x 1¼"
<b>1309528</b>	Cross clamp   wide   hot dipped galvanized   1½" x 1½"
<b>1309523</b>	Cross clamp   wide   hot dipped galvanized   2" x 1½"
<b>1309524</b>	Cross clamp   wide   hot dipped galvanized   2" x 2"
<b>1309525</b>	Cross clamp   wide   hot dipped galvanized   2½" x 1½"
<b>1309526</b>	Cross clamp   wide   hot dipped galvanized   2½" x 2"
<b>1309527</b>	Cross clamp   wide   hot dipped galvanized   2½" x 2½"



## T-clamp 90°

<b>1301546</b>	T-clamp	90°	hot dipped galvanized	¾" x ¾"
<b>1301548</b>	T-clamp	90°	hot dipped galvanized	¾" x 1"
<b>1301550</b>	T-clamp	90°	hot dipped galvanized	1" x 1"
<b>1301564</b>	T-clamp	90°	hot dipped galvanized	1" x 1¼"
<b>1301552</b>	T-clamp	90°	hot dipped galvanized	1" x 1½"
<b>1301554</b>	T-clamp	90°	hot dipped galvanized	1¼" x 1¼"
<b>1301556</b>	T-clamp	90°	hot dipped galvanized	1¼" x 1½"
<b>1301562</b>	T-clamp	90°	hot dipped galvanized	1½" x 1½"
<b>1301558</b>	T-clamp	90°	hot dipped galvanized	1½" x 2"
<b>1310712</b>	T-clamp	90°	hot dipped galvanized	1½" x 2½"
<b>1307909</b>	T-clamp	90°	hot dipped galvanized	2" x 1½"
<b>1301560</b>	T-clamp	90°	hot dipped galvanized	2" x 2"
<b>1310848</b>	T-clamp	90°	hot dipped galvanized	2" x 2½"



## Tube crossing

<b>1301639</b>	Tube crossing	hot dipped galvanized	1½" x 1½"
<b>1301638</b>	Tube crossing	hot dipped galvanized	1½" x 2"
<b>1301602</b>	Tube crossing	electrolytically galvanized	1¼" x 1¼"



## Pipe support

<b>1301870</b>	Pipe support	hot dipped galvanized	½"
<b>1301871</b>	Pipe support	hot dipped galvanized	¾"
<b>1301872</b>	Pipe support	hot dipped galvanized	1"
<b>1301873</b>	Pipe support	hot dipped galvanized	1¼"
<b>1301874</b>	Pipe support	hot dipped galvanized	1½"
<b>1301875</b>	Pipe support	hot dipped galvanized	2"



## U-bracket hot dipped galvanized

<b>1301472</b>	U-bracket	hot dipped galvanized	¾" x ¾"
<b>1301456</b>	U-bracket	hot dipped galvanized	½" x ½"
<b>1301460</b>	U-bracket	hot dipped galvanized	½" x 1"
<b>1301463</b>	U-bracket	hot dipped galvanized	½" x 1¼"
<b>1301466</b>	U-bracket	hot dipped galvanized	½" x 1½"
<b>1301469</b>	U-bracket	hot dipped galvanized	½" x 2"
<b>1301474</b>	U-bracket	hot dipped galvanized	¾" x 1"
<b>1301477</b>	U-bracket	hot dipped galvanized	1" x 1"
<b>1301479</b>	U-bracket	hot dipped galvanized	1" x 1¼"
<b>1301481</b>	U-bracket	hot dipped galvanized	1" x 1½"
<b>1301485</b>	U-bracket	hot dipped galvanized	1¼" x 1¼"
<b>1301486</b>	U-bracket	hot dipped galvanized	1¼" x 1½"



## U-bracket electrolytically galvanized

<b>1301459</b>	U-bracket	electrolytically galvanized	½" x 1"
<b>1301462</b>	U-bracket	electrolytically galvanized	½" x 1¼"
<b>1301465</b>	U-bracket	electrolytically galvanized	½" x 1½"
<b>1301468</b>	U-bracket	electrolytically galvanized	½" x 2"
<b>1301478</b>	U-bracket	electrolytically galvanized	1" x 1¼"
<b>1301491</b>	U-bracket	electrolytically galvanized	2" x 2"



## Threaded clamp

<b>1307890</b>	Threaded clamp	electrolytically galvanized	¾"	M8	45 mm
<b>1301620</b>	Threaded clamp	electrolytically galvanized	1"	M8	60 mm
<b>1301622</b>	Threaded clamp	electrolytically galvanized	1"	M8	75 mm
<b>1301616</b>	Threaded clamp	electrolytically galvanized	1¼"	M6	60 mm
<b>1301624</b>	Threaded clamp	electrolytically galvanized	1¼"	M8	70 mm
<b>1301627</b>	Threaded clamp	electrolytically galvanized	1½"	M8	75 mm
<b>1301626</b>	Threaded clamp	electrolytically galvanized	1½"	M8	85 mm
<b>1301635</b>	Threaded clamp	electrolytically galvanized	1½"	M10	85 mm
<b>1308097</b>	Threaded clamp	electrolytically galvanized	1½"	M10	100 mm
<b>1301630</b>	Threaded clamp	electrolytically galvanized	2"	M8	88 mm
<b>1301631</b>	Threaded clamp	electrolytically galvanized	2"	M8	110 mm
<b>1308100</b>	Threaded clamp	electrolytically galvanized	2"	M10	85 mm
<b>1307896</b>	Threaded clamp	electrolytically galvanized	2"	M10	100 mm
<b>1307897</b>	Threaded clamp	electrolytically galvanized	2"	M10	110 mm
<b>1308101</b>	Threaded clamp	electrolytically galvanized	2"	M10	120 mm
<b>1301636</b>	Threaded clamp	electrolytically galvanized	2½"	M10	120 mm



## Double spacer bracket

<b>1301515</b>	Double spacer bracket	1¼" x 50,80 mm	hot dip galvanized
<b>1301516</b>	Double spacer bracket	1½" x 50,80 mm	hot dip galvanized
<b>1301519</b>	Double spacer bracket	1½" x 34/40 mm	hot dip galvanized



## Counter plate

<b>1301599</b>	Counter plate	electrolytically galvanized	1¼"	M8/M10
<b>1301597</b>	Counter plate	electrolytically galvanized	2"	M8/M10



## S/S snap hooks

<b>1301825</b>	Snap hook	S/S	5 x 50 mm
<b>1301672</b>	Snap hook	S/S	6 x 60 mm
<b>1301942</b>	Snap hook	S/S	7 x 70 mm
<b>1301943</b>	Snap hook	S/S	5 x 50 mm   with eye



## Plastic snap hooks

1311291	Snap hook   plastic   white   corr. DeLaval 966.648-01
1330095	Snap hook   plastic   black   corr. DeLaval 915.564-01



## Pulley

1301662	Pulley   50 mm
---------	----------------



## Sleeve

1301657	Sleeve   2½"
---------	--------------



## Pipe coupling

1301658	Pipe coupling   plastic   ¾"
1301659	Pipe coupling   plastic   1"
1301660	Pipe coupling   plastic   1½"
1301661	Pipe coupling   plastic   2"



## Non-kick bar

1301066	Non-kick bar
1310134	Spring   9 mm   new model
1301069	Cap set



## Cable bundle straps

0120058	Cable bundle straps   collection tube   850 pieces
---------	--



## Cable bundle straps natural

<b>0120064</b>	Cable bundle straps   natural   190 x 4,8 mm   bag of 100 pieces
<b>0120065</b>	Cable bundle straps   natural   280 x 4,8 mm   bag of 100 pieces
<b>0120066</b>	Cable bundle straps   natural   368 x 4,8 mm   bag of 100 pieces
<b>0120067</b>	Cable bundle straps   natural   203 x 4,8 mm   bag of 100 pieces
<b>0120068</b>	Cable bundle straps   natural   380 x 4,8 mm   bag of 100 pieces



## S/S hose clamp, entirely S/S

<b>1309862</b>	Hose clamp   S/S   8-16 mm
<b>1301687</b>	Hose clamp   S/S   12-22 mm
<b>1301688</b>	Hose clamp   S/S   16-27 mm
<b>1301689</b>	Hose clamp   S/S   25-40 mm
<b>1309864</b>	Hose clamp   S/S   40-60 mm
<b>1300500</b>	Hose clamp   S/S   32-50 mm
<b>1300501</b>	Hose clamp   S/S   50-70 mm
<b>1300502</b>	Hose clamp   S/S   60-80 mm
<b>1300530</b>	Hose clamp   S/S   90-110 mm
<b>1300531</b>	Hose clamp   S/S   100-120 mm
<b>1300503</b>	Hose clamp   S/S   80-100 mm
<b>1300504</b>	Hose clamp   S/S   32-50 mm   cut version
<b>1300505</b>	Hose clamp   S/S   50-70 mm   cut version
<b>1300506</b>	Hose clamp   S/S   60-80 mm   cut version
<b>1300507</b>	Hose clamp   S/S   80-100 mm   cut version



## Trough

<b>1316580</b>	Trough   Thermo Quell   model 630   1 ball   40 ltr.
----------------	--



## Dosing motor corr. GEA

<b>1316020</b>	Dosing motor   40rpm   24V DC   grey   with cable   corr. GEA
<b>1316030</b>	Dosing motor   40rpm   24V DC   grey   without cable   corr. GEA





## Dosing motor corr. Nedap/GEA/Miele/Lely/Manus/SAC

**1316010** Dosing motor | Solid State 5 | 28rpm | VC3-VC4 | corr. Nedap/  
GEA/Miele/Lely/Manus/SAC



## Auger

**1316040** Auger | 100 gram | complete



## Parts for auger

**1316050** Cup | S/S

**1316108** Shaft

**1316060** Bolt | M6 x 95 | A2 | DIN 931

**1316070** Isolationelement | plastic

**1316080** Coupling | white | M8

**1316090** Isolation paper

**1316105** Motor frame and augertube

**1316180** Revision | S/S | for feed station | 1,5 mm | including partition |  
corr. Nedap

**1316170** Holder | S/S | for eating bowl | corr. GEA feedstation



## Spring

**1301667** Torsion spring Kilomatic

**1301665** S/S spring Kilomatic/Piccolo | Ø 20 x 50 mm

**1301666** S/S spring for ACB for feeding machine | Ø 20 x 135 mm

**1301668** S/S spring | Happy around | corr. DeLaval



## Crouzet motor

**1316140** Crouzet motor | 24V AC | 50 Hz | nom. | 6rpm | no. 82662558 |  
corr. Gascoigne Melotte ID 2000

**1316130** Crouzet motor | 24V AC | 50 HZ | nom. | 8rpm | no. 82662532  
| corr. Fullwood



## Drive motor

**1316120** Drive motor | 24V AC | 6rpm | nr. 80547029



## Parts for Crouzet motor

**1316160** Rear bar | no. 79207195

**1316145** Ball bearing | no. 23313606

**1316150** Ball bearing cartridge | no. 75520137



## Capacitor

**1316125** Capacitor | on print | 22uf



## Cow identification straps

**1307433** Cow identification straps | red | 10 pieces

**1307434** Cow identification straps | blue | 10 pieces

**1307435** Cow identification straps | yellow | 10 pieces

**1307436** Cow identification straps | green | 10 pieces



## Cow identification straps velcro

**1307437** Cow identification straps | velcro | red | 10 pieces

**1307438** Cow identification straps | velcro | blue | 10 pieces

**1307439** Cow identification straps | velcro | yellow | 10 pieces

**1307440** Cow identification straps | velcro | green | 10 pieces



## Ruminal magnet

**1316560** Ruminal magnet | white

**1316565** Ruminal magnet | green



## Cow ID curtain corr. DeLaval 984.523-80

**1307430** Cow ID curtain | corr. DeLaval 984.523-80



## Manure strip corr. Lely Discovery

**1307415** Manure strip | manure robot | corr. Lely Discovery



## Teat cup cord corr. Lely A3/A4/A5

**1311582** Teat cup cord | milk robot | 3 meter | corr. Lely A3/A4/A5





Chapter 14

# PASTURE PUMP PARTS

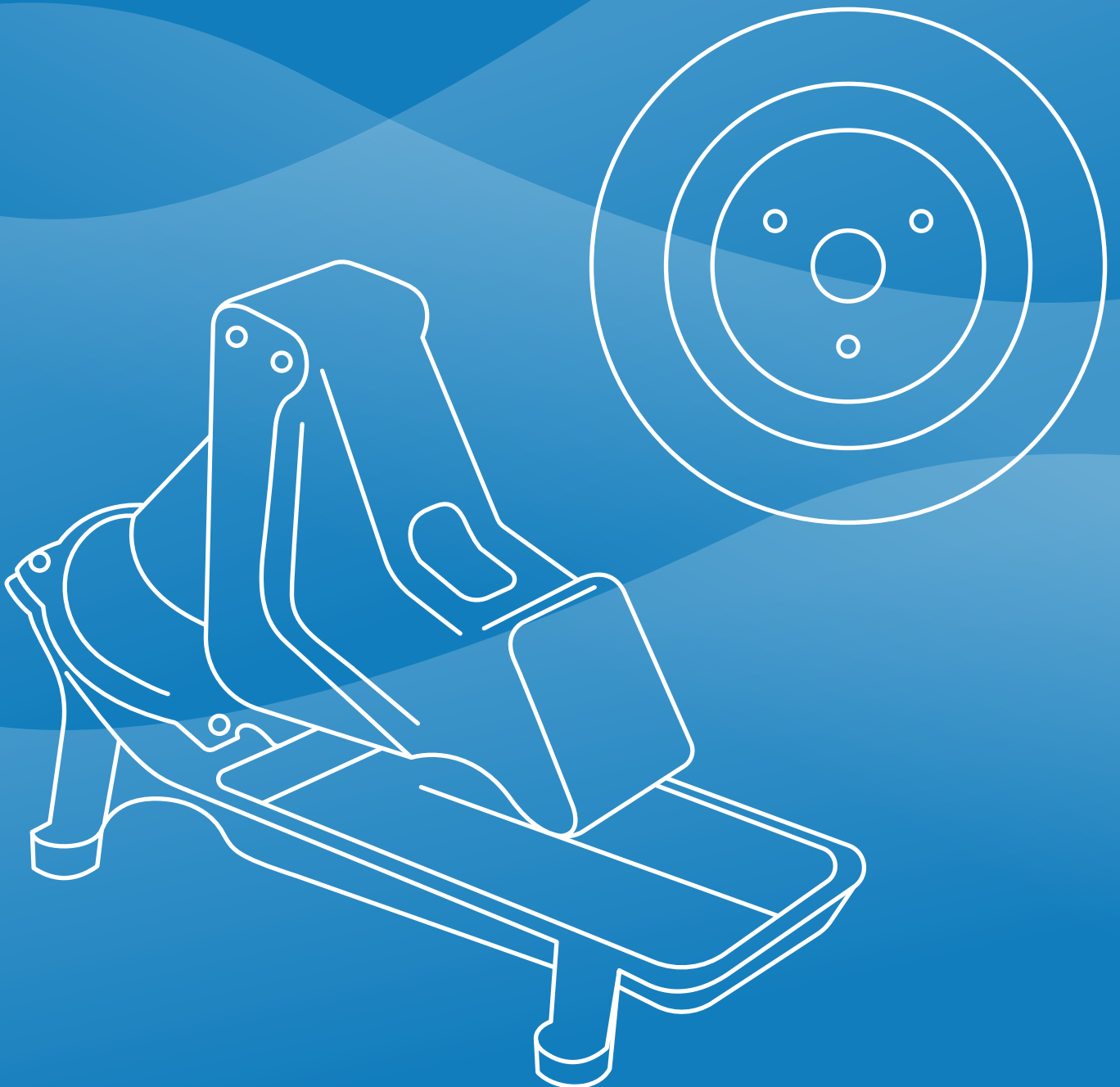

## Chapter 14 Pasture pump parts

Diaphragm for pasture pump corr. Ipsa	P202
Diaphragm for pasture pump corr. Lister/Suevia	P202
Diaphragm for pasture pump corr. Eider	P202
Diaphragm for pasture pump corr. Oase	P202
Diaphragm for pasture pump corr. Utina/Holstebro	P202
Repair kit for pasture pump corr. Utina/Holstebro	P202
Repair kit for pasture pump corr. Oase	P202
Bushing	P203
U-ring	P203
Shaft corr. Lister L3 and Lister L4	P203
Bolt and nuts corr. Lister L3 and Lister L4	P203
Seal connection piece corr. Lister L3 and Lister L4	P203
Valve cones corr. Lister L3 and Lister L4	P203
Valve cones corr. Oase 75	P203
Valve cones rubber corr. Utina	P203
Diaphragm holder corr. Utina	P204
Diaphragm holder corr. Lister	P204
Brass connection piece corr. Lister	P204
Plastic sleeve corr. Lister	P204
Molded connection piece corr. Oase	P204
Brass bushing for connection piece corr. Oase	P204
Seal connection piece	P204

## Diaphragm for pasture pump corr. Ipsa

<b>1301410</b>	Diaphragm   pasture pump   rubber   Ø 255   corr. Ipsa Junior
<b>1301411</b>	Diaphragm   pasture pump   rubber   Ø 255   corr. Ipsa St. Hubert
<b>1301416</b>	Diaphragm   pasture pump   rubber   Ø 250   corr. Ipsa Kadett/Scala



## Diaphragm for pasture pump corr. Lister/Suevia

<b>1301415</b>	Diaphragm   pasture pump   rubber   Ø 215   corr. Lister/Suevia
----------------	---



## Diaphragm for pasture pump corr. Eider

<b>1301414</b>	Diaphragm   pasture pump   rubber   Ø 225   corr. Eider
----------------	---



## Diaphragm for pasture pump corr. Oase

<b>1301413</b>	Diaphragm   pasture pump   rubber   Ø 230   corr. Oase
----------------	--



## Diaphragm for pasture pump corr. Utina/Holstebro

<b>1301412</b>	Diaphragm   pasture pump   rubber   Ø 230   corr. Utina/Holstebro
----------------	---



## Repair kit for pasture pump corr. Utina/Holstebro

<b>1301417</b>	Repair kit   corr. Utina/Holstebro M40
<b>1301419</b>	Set shafts and bushings   S/S   corr. Utina/Holstebro
<b>1301418</b>	Set shafts   S/S   corr. Utina/Holstebro 2880000



## Repair kit for pasture pump corr. Oase

<b>1301430</b>	Repair kit   corr. Oase type 75
<b>1301433</b>	Set shafts and bushings   galvanized   corr. Oase
<b>1301432</b>	Set shafts   galvanized   corr. Oase

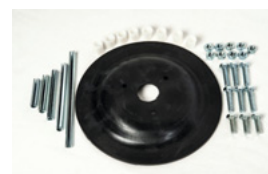

## Bushing

1301421	Bushing   nylon   Utina 18   corr. 2870012
1301422	Bushing   nylon   Utina 19   corr. 2870013
1301431	Bushing   nylon   Oase   11,5 x 16,3 x 18,3 mm   corr. 012



## U-ring

1301426	U-ring   corr. Utina 27
---------	-------------------------



## Shaft corr. Lister L3 and Lister L4

1301446	Shaft   52 mm   corr. Lister L3 and Lister L4
---------	---



## Bolt and nuts corr. Lister L3 and Lister L4

1301447	Bolt   two M10 inox nuts   116 mm   corr. Lister L3 and Lister L4
---------	---



## Seal connection piece corr. Lister L3 and Lister L4

1301451	Seal connection piece   corr. Lister L3 and Lister L4
---------	---



## Valve cones corr. Lister L3 and Lister L4

1301549	Valve cone   small   down   corr. Lister L3 and Lister L4
1301559	Valve cone   big   top   corr. Lister L3 and Lister L4



## Valve cones corr. Oase 75

1301536	Valve cone   corr. Oase 75
---------	----------------------------



## Valve cones rubber corr. Utina

1301425	Valve cone   rubber   corr. Utina 2870019
---------	---





## Diaphragm holder corr. Utina

**1301420** Diaphragm holder | plastic | corr. Utina 2870007/009



## Diaphragm holder corr. Lister

**1301438** Diaphragm holder | plastic | corr. Lister



## Brass connection piece corr. Lister

**1316325** Connection piece | brass | corr. Lister



## Plastic sleeve corr. Lister

**1301545** Plastic sleeve | corr. Lister



## Molded connection piece corr. Oase

**1316324** Connection piece | molded | corr. Oase



## Brass bushing for connection piece corr. Oase

**1316325** Bushing for connection piece | brass | corr. Oase



## Seal connection piece

**1316326** Seal for connection piece | corr. Oase

**1316328** Seal for connection piece | corr. Eider



Chapter 15

# GOATS AND SHEEP



# Chapter 15 Goats and sheep

Milking cluster for mini milkers and milk buckets, goats	P207
Milking cluster for mini milkers and milk buckets, sheep	P207
ITP 203 milk claw	P207
ITP 205 milk claw	P208
ITP 207 milk claw	P208
Cap for claw 1301914	P208
Valve for claw 1301914	P208
Milk claw	P208
Teat cup shell & liner goats corr. DeLaval G10	P208
Liner goats corr. DeLaval	P208
Teat cup shell & liner sheep corr. DeLaval S10	P209
Teat cup shell & liner sheep 110 mm	P209
Teat cup shell & liner sheep corr. Fullwood	P209
Teat cup shell & liner goats	P209
Teat cup shell & liner goats corr. Fullwood	P209
Teat cup shell & liner sheep	P210
Teat cup shell & liner goats corr. Westfalia	P210
Liners	P210
Teat cup shell & liner goats 147 mm	P210
Teat cup shell & liner sheep 159 mm	P210
Jettercup corr. DeLaval Ø 44 mm	P210
Jettercup corr. DeLaval Ø 40,5 mm	P211
Jettercup corr. DeLaval Ø 41,5 mm	P211
Jettercup corr. Surge	P211
Jettercup	P211
Pulsator Nedlac for sheep and goats	P211
Milk bucket S/S complete goats	P211
Milk bucket plastic complete goats blue	P212
Milk bucket plastic complete goats green	P212
Milk bucket plastic complete goats orange	P212
Milk bucket S/S complete sheep	P212
Milk bucket plastic complete sheep blue	P212
Milk bucket plastic complete sheep green	P213
Milk bucket plastic complete sheep orange	P213
Control lid	P213
Transport lid	P213
Libero lid with connection point pulsator	P213
Mini milker Friesland with S/S bucket	P213

Mini milker Friesland with plastic bucket	P214
Mini milker Groningen with S/S bucket	P214
Mini milker Groningen with plastic bucket	P214
Mini milker Brabant	P214
Mini milker Holland	P214
Mini milker Moby	P214
Parts for mini milkers	P215
Mini milker Friesland with S/S bucket	P215
Mini milker Friesland with plastic bucket	P215
Mini milker Groningen with S/S bucket	P215
Mini milker Groningen with plastic bucket	P215
Mini milker Brabant	P216
Mini milker Holland	P216
Mini milker Moby	P216
Parts for mini milkers	P216
Diaphragm corr. DeLaval Almatic	P217
Y-piece S/S	P217
Milk meter goats/sheep	P217
General	P217
Advice	P217

## Milking cluster for mini milkers and milk buckets, goats

<b>1301908</b>	Milking cluster   19 mm   goats   complete
<b>1301910</b>	Liner   19 mm - 8 mm   length 147 mm   goats
<b>1308220</b>	Jettercup   Ø 52 mm   rubber   short model   corr. Surge 21136
<b>1308222</b>	Tube   for jettercup   corr. Surge 21592
<b>1301912</b>	Teat cup shell   plastic   goats
<b>1301914</b>	Claw bowl   plastic   automatic valve   goats/sheep
<b>1300348</b>	Pulsation tube   short   rubber   7 x 230 x 7 mm   red line
<b>1301915</b>	Y-piece   12 x 14 mm   milk tube
<b>1301916</b>	Y-piece   6 x 10 mm   pulsation tube
<b>1301917</b>	Bracket   plastic   blue
<b>1300351</b>	Milk tube   short   rubber   10 x 180 x 8,5 mm   6 ridges at one side   conical   corr. Westfalia 7027.2637.090



## Milking cluster for mini milkers and milk buckets, sheep

<b>1301909</b>	Milking cluster   17,5 mm   sheep   complete
<b>1301911</b>	Liner   17,5 mm - 8 mm   length 159 mm   sheep
<b>1308221</b>	Jettercup   Ø 43 mm   short model   corr. Fullwood
<b>1301913</b>	Teat cup shell   plastic   sheep
<b>1301914</b>	Milk claw   plastic   automatic valve   goats/sheep
<b>1300348</b>	Pulsation tube   short   rubber   7 x 230 x 7 mm   red line
<b>1301915</b>	Y-piece   12 x 14 mm   milk tube
<b>1301916</b>	Y-piece   6 x 10 mm   pulsation tube
<b>1301917</b>	Bracket   plastic   blue
<b>1300351</b>	Milk tube   short   rubber   10 x 180 x 8,5 mm   6 ridges at one side   conical   corr. Westfalia 7027.2637.090



## ITP 203 milk claw

<b>1311626</b>	Milk claw   ITP203   without valve   with airvent   goats/sheep
<b>1308290</b>	Milk claw   ITP203   with valve   with airvent   goats/sheep
<b>1308291</b>	Milk claw   ITP203   with valve   without airvent   goats/sheep



## ITP 205 milk claw

**1308248** Milk claw | ITP 205 | goats/sheep



## ITP 207 milk claw

**1308293** Milk claw | ITP207 | automatic valve | goats/sheep



## Cap for claw 1301914

**1301923** Cap | rubber | milk claw goats/sheep



## Valve for claw 1301914

**1309563** Valve | round | milk claw goats/sheep



## Milk claw

**1301924** Milk claw | 125 cc | 135 gram | goats/sheep | complete



## Teat cup shell & liner goats corr. DeLaval G10

**1310364** Teat cup shell | plastic | goats | corr. DeLaval 961.429-01 Almatic G10

**1308179** Liner | Ø 22 mm | silicone | goats | corr. DeLaval 961.430-01 Almatic G10

**1308176** Liner | Ø 22 mm | rubber | goats | corr. DeLaval 961.430-01 Almatic G10



## Liner goats corr. DeLaval

**1308180** Liner | Ø 21 mm | silicone | goats | corr. DeLaval 988.513-01 G50

**1312058** Liner | Ø 19 mm | silicone | goats | corr. DeLaval 988.513-01 G50

**1312051** Liner | Ø 21 mm | rubber | goats | corr. DeLaval 988.513-01 G50



## Teat cup shell & liner sheep corr. DeLaval S10

<b>1308211</b>	Teat cup shell   plastic   sheep   corr. DeLaval 961.404-01 Almatic S10
<b>1308209</b>	Liner   Ø 17 mm   silicone   short   sheep   corr. DeLaval 961.403-01 Almatic S10
<b>1308210</b>	Liner   Ø 18 mm   rubber   short   sheep   corr. DeLaval 961.403-01 Almatic S10



## Teat cup shell & liner sheep 110 mm

<b>1312059</b>	Teat cup shell   plastic   length 110 mm
<b>1310534</b>	Liner   Ø 19 mm   silicone   right-angled   sheep   corr. DeLaval 986.836-02



## Teat cup shell & liner sheep corr. Fullwood

<b>1310396</b>	Teat cup shell   plastic   sheep
<b>1310392</b>	Liner   Ø 19,5 mm   silicone   right-angled   sheep   corr. Fullwood 20150
<b>1310395</b>	Liner   Ø 17 mm   silicone   sheep   corr. Fullwood 20160
<b>1312069</b>	Liner   Ø 19 mm   silicone   sheep   corr. SAC 252.000.138



## Teat cup shell & liner goats

<b>1308289</b>	Teat cup shell   plastic   goats
<b>1310390</b>	Liner   Ø 20 mm   rubber   long   goats
<b>1310391</b>	Liner   Ø 20 mm   silicone   long   goats
<b>1301678</b>	Liner   Ø 20 mm   silicone   long   goats   corr. Fullwood 20236



## Teat cup shell & liner goats corr. Fullwood

<b>1301920</b>	Teat cup shell   136 mm   long   plastic   goats
<b>1301919</b>	Liner   Ø 20 mm   silicone   right-angled   goats   corr. Fullwood 020141
<b>1301918</b>	Set teat cup shell and liner   1301920+1301919



## Teat cup shell & liner sheep

<b>1310394</b>	Teat cup shell   plastic   sheep
<b>1310399</b>	Liner   Ø 19,5 mm   rubber   short (140 mm)   sheep
<b>1310393</b>	Liner   Ø 17 mm   silicone   short (130 mm)   sheep



## Teat cup shell & liner goats corr. Westfalia

<b>1312107</b>	Teat cup shell   plastic   corr. Westfalia Topflow 7036.2722.100
<b>1312109</b>	Holder for teat cup shell   corr. Westfalia Topflow 7036.2722.110
<b>1312062</b>	Liner   Ø 22 mm   silicone   short   goats   corr. Westfalia 7036.2725.170



## Liners

<b>1301921</b>	Liner   Ø 22 mm   rubber   long   goats   corr. Manus 965143
<b>1301922</b>	Liner   Ø 22 mm   rubber   long   goats   corr. Gascoigne Melotte 750.521
<b>1308395</b>	Liner   Ø 21 mm   rubber   long   goats   corr. Gascoigne Melotte 381.448
<b>1307554</b>	Liner   Ø 22 mm   rubber   long   goats   corr. Westfalia 7036.2725.060
<b>1312061</b>	Liner   Ø 19 mm   silicone   short   sheep   corr. Westfalia 7036.2725.140



## Teat cup shell & liner goats 147 mm

<b>1301910</b>	Liner   19 mm - 8 mm   length 147 mm   goats
<b>1301912</b>	Teat cup shell   plastic   goats



## Teat cup shell & liner sheep 159 mm

<b>1301911</b>	Liner   17,5 mm - 8 mm   length 159 mm   sheep
<b>1301913</b>	Teat cup shell   plastic   sheep



## Jettercup corr. DeLaval Ø 44 mm

<b>1308207</b>	Jettercup   Ø 44 mm   rubber   sheep   corr. DeLaval 70290921
----------------	---





## Jettercup corr. DeLaval Ø 40,5 mm

1308208 Jettercup | Ø 40,5 mm | rubber | sheep | corr. DeLaval 961407



## Jettercup corr. DeLaval Ø 41,5 mm

1310402 Jettercup | Ø 41,5 mm | rubber | sheep | corr. DeLaval



## Jettercup corr. Surge

1308220 Jettercup | Ø 52 mm | rubber | short model | corr. Surge 21136

1308222 Tube | for jettercup | corr. Surge 21592



## Jettercup

1310400 Jettercup | Ø 44 mm | rubber | sheep | universal



## Pulsator Nedlac for sheep and goats

1311475 Pulsator | Nedlac | blue lid | 60:40 | 90 beats | goats

1311477 Pulsator | Nedlac | blue lid | 60:40 | 120 beats | sheep

1311478 Pulsator | Nedlac | blue lid | 50:50 | 120 beats | sheep



## Milk bucket S/S complete goats

1307539 Milk bucket | S/S | 30 ltr. | 1 milking cluster | goats | complete

1310265 Milk bucket | S/S | 30 ltr. | 2 milking clusters | goats | complete

1301908 Milking cluster | 19 mm | goats | complete

1311475 Pulsator | Nedlac | blue lid | 60:40 | 90 beats | goats



## Milk bucket plastic complete goats blue

<b>1310522</b>	Milk bucket   plastic   blue   30 ltr.   1 milking cluster   goats   complete
<b>1309851</b>	Milk bucket   plastic   blue   30 ltr.   2 milking clusters   goats   complete
<b>1301908</b>	Milking cluster   19 mm   goats   complete
<b>1311475</b>	Pulsator   Nedlac   blue lid   60:40   90 beats   goats



## Milk bucket plastic complete goats green

<b>1310525</b>	Milk bucket   plastic   green   30 ltr.   goats   complete
<b>1301908</b>	Milking cluster   19 mm   goats   complete
<b>1311475</b>	Pulsator   Nedlac   blue lid   60:40   90 beats   goats



## Milk bucket plastic complete goats orange

<b>1310528</b>	Milk bucket   plastic   orange   30 ltr.   goats   complete
<b>1301908</b>	Milking cluster   19 mm   goats   complete
<b>1311475</b>	Pulsator   Nedlac   blue lid   60:40   90 beats   goats



## Milk bucket S/S complete sheep

<b>1310765</b>	Milk bucket   S/S   30 ltr.   1 milking cluster   sheep   complete
<b>1310500</b>	Milk bucket   S/S   30 ltr.   2 milking clusters   sheep   complete
<b>1301909</b>	Milking cluster   17,5 mm   sheep   complete
<b>1311478</b>	Pulsator   Nedlac   blue lid   50:50   120 beats   sheep



## Milk bucket plastic complete sheep blue

<b>1310523</b>	Milk bucket   plastic   blue   30 ltr.   1 milking cluster   sheep   complete
<b>1311085</b>	Milk bucket   plastic   blue   30 ltr.   2 milking clusters   sheep   complete
<b>1301909</b>	Milking cluster   17,5 mm   sheep   complete
<b>1311478</b>	Pulsator   Nedlac   blue lid   50:50   120 beats   sheep



## Milk bucket plastic complete sheep green

<b>1310526</b>	Milk bucket   plastic   green   30 ltr.   sheep   complete
<b>1301909</b>	Milking cluster   17,5 mm   sheep   complete
<b>1311478</b>	Pulsator   Nedlac   blue lid   50:50   120 beats   sheep



## Milk bucket plastic complete sheep orange

<b>1310529</b>	Milk bucket   plastic   orange   30 ltr.   sheep   complete
<b>1301909</b>	Milking cluster   17,5 mm   sheep   complete
<b>1311478</b>	Pulsator   Nedlac   blue lid   50:50   120 beats   sheep



## Control lid

<b>1309677</b>	Control lid   plastic   2 inlets Ø 17 mm and 1 inlet Ø 14 mm   complete
<b>1307526</b>	Gasket for lid   rubber



## Transport lid

<b>1308704</b>	Transport lid   rubber   black   fits plastic and S/S buckets
----------------	---



## Libero lid with connection point pulsator

<b>1310539</b>	Libero lid   1 inlet Ø 14 x 19 mm   handle height 143 mm   complete
<b>1310540</b>	Libero lid   1 inlet Ø 16 x 21 mm   handle height 143 mm   complete
<b>1309905</b>	Gasket for lid   rubber
<b>1310735</b>	Hook



## Mini milker Friesland with S/S bucket

<b>1307505</b>	Mini milker Friesland   1 S/S bucket   1 milking cluster   goats
<b>1309704</b>	Mini milker Friesland   1 S/S bucket   2 milking clusters   goats



## Mini milker Friesland with plastic bucket

<b>1314013</b>	Mini milker Friesland   1 plastic bucket   blue   1 milking cluster   goats
<b>1314016</b>	Mini milker Friesland   1 plastic bucket   blue   2 milking clusters   goats



## Mini milker Groningen with S/S bucket

<b>1307513</b>	Mini milker Groningen   1 S/S bucket   1 milking cluster   goats
<b>1309900</b>	Mini milker Groningen   1 S/S bucket   2 milking clusters   goats



## Mini milker Groningen with plastic bucket

<b>1314028</b>	Mini milker Groningen   1 plastic bucket   blue   1 milking cluster   goats
<b>1314031</b>	Mini milker Groningen   1 plastic bucket   blue   2 milking clusters   goats



## Mini milker Brabant

<b>1307506</b>	Mini milker Brabant   2 S/S buckets   2 milking clusters   goats
<b>1309890</b>	Mini milker Brabant   2 S/S buckets   4 milking clusters   goats



## Mini milker Holland

<b>1307502</b>	Mini milker Holland   petrol engine   2 S/S buckets   2 milking clusters   goats
<b>1310501</b>	Mini milker Holland   petrol engine   2 S/S buckets   4 milking clusters   goats



## Mini milker Moby

<b>1312361</b>	Mini milker Moby   oil lubricated   S/S bucket 25 ltr.   plastid lid   goats
<b>1312357</b>	Mini milker Moby   oil lubricated   plastic bucket 30 ltr.   plastic lid   goats
<b>1310236</b>	Mini milker Moby   S/S bucket 25 ltr.   plastic lid   goats
<b>1312371</b>	Mini milker Moby   plastic bucket 30 ltr.   plastic lid   goats
<b>1310278</b>	Vane   graphite   70 x 42,9 x 5 mm



*Several parts on request*

## Parts for mini milkers

<b>1301908</b>	Milking cluster   19 mm   goats   complete
<b>1307519</b>	Vacuum pump and electric motor   200 ltr.   1 hp   dry
<b>1307529</b>	Vane   graphite   65 x 45 x 4,8 mm   standard model for all mini milkers
<b>1301010</b>	Vacuum meter   dry   black   Ø 63 mm   ¼" BSP connection
<b>1311012</b>	Silencer
<b>1310764</b>	Shaft seal   for electric motor
<b>1310816</b>	Condensator
<b>1308374</b>	Switch
<b>1307530</b>	Housing   for electro box
<b>1311335</b>	Lid   for housing
<b>1309906</b>	Cap   square
<b>1307532</b>	Cap   round   for frame mini milker Friesland
<b>1309831</b>	Wheel   for mini milker Friesland



## Mini milker Friesland with S/S bucket

<b>1307503</b>	Mini milker Friesland   1 S/S bucket   1 milking cluster   sheep
<b>1310520</b>	Mini milker Friesland   1 S/S bucket   2 milking clusters   sheep



## Mini milker Friesland with plastic bucket

<b>1314019</b>	Mini milker Friesland   1 plastic bucket   blue   1 milking cluster   sheep
<b>1314022</b>	Mini milker Friesland   1 plastic bucket   blue   2 milking clusters   sheep



## Mini milker Groningen with S/S bucket

<b>1307514</b>	Mini milker Groningen   1 S/S bucket   1 milking cluster   sheep
<b>1310325</b>	Mini milker Groningen   1 S/S bucket   2 milking clusters   sheep



## Mini milker Groningen with plastic bucket

<b>1314034</b>	Mini milker Groningen   1 plastic bucket   blue   1 milking cluster   sheep
<b>1314037</b>	Mini milker Groningen   1 plastic bucket   blue   2 milking clusters   sheep



## Mini milker Brabant

<b>1307507</b>	Mini milker Brabant   2 S/S buckets   2 milking clusters   sheep
<b>1310851</b>	Mini milker Brabant   2 S/S buckets   4 milking clusters   sheep



## Mini milker Holland

<b>1308416</b>	Mini milker Holland   petrol engine   2 S/S buckets   2 milking clusters   sheep
----------------	--



## Mini milker Moby

<b>1312364</b>	Mini milker Moby   oil lubricated   S/S bucket 25 ltr.   plastid lid   sheep
<b>1312359</b>	Mini milker Moby   oil lubricated   plastic bucket 30 ltr.   plastic lid   sheep
<b>1310237</b>	Mini milker Moby   S/S bucket 25 ltr.   plastid lid   sheep
<b>1312373</b>	Mini milker Moby   plastic bucket 30 ltr.   plastic lid   sheep
<b>1310278</b>	Vane   graphite   70 x 42,9 x 5 mm <i>Several parts on request</i>



## Parts for mini milkers

<b>1301909</b>	Milking cluster   17,5 mm   sheep   complete
<b>1307519</b>	Vacuum pump and electric motor   200 ltr.   1 hp   dry
<b>1307529</b>	Vane   graphite   65 x 45 x 4,8 mm   standard model for all mini milkers
<b>1301010</b>	Vacuum meter   dry   black   Ø 63 mm   ¼" BSP connection
<b>1311012</b>	Silencer
<b>1310764</b>	Shaft seal   for electric motor
<b>1310816</b>	Condensator
<b>1308374</b>	Switch
<b>1307530</b>	Housing   for electro box
<b>1311335</b>	Lid   for housing electro box
<b>1309906</b>	Cap   square
<b>1307532</b>	Cap   round   for frame mini milker Friesland
<b>1309831</b>	Wheel   for mini milker Friesland



## Diaphragm corr. DeLaval Almatic

1312052 Diaphragm | corr. DeLaval Almatic 989.917-01



## Y-piece S/S

1330038 Y-piece | S/S | 12 x 1,5 mm | length 100 mm

1330039 Y-piece | S/S | 18 x 1,5 mm | length 170 mm



## Milk meter goats/sheep

1312110 Milk meter | goats and sheep | corr. Waikato MK4 4,7 ltr.



## General

Mini milkers are fully-fledged mobile milking machines and available in versions for cows, goats and sheep. The compact design on a solid frame with large, easy-to-drive wheels increases the ease of use.

All our mini milkers are delivered including a bucket (stainless steel or plastic), a lid (with overflow protection), a milking cluster, a vacuum meter, a vacuum regulator, a vacuum valve, a pulsator and tubing. This complete scope of delivery including the clear manual is the perfect "Plug & Play" solution.

## Advice

The non-lubricated versions of the mini milker should run approximately 3 minutes each week to prevent the self-lubricating paddles from getting stuck in the pump.









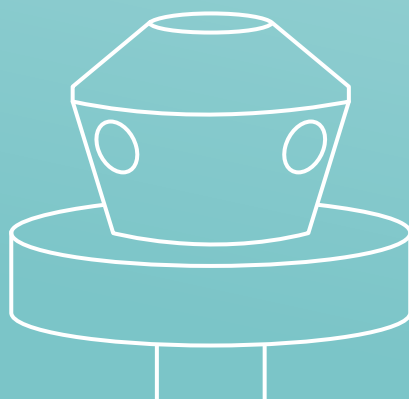
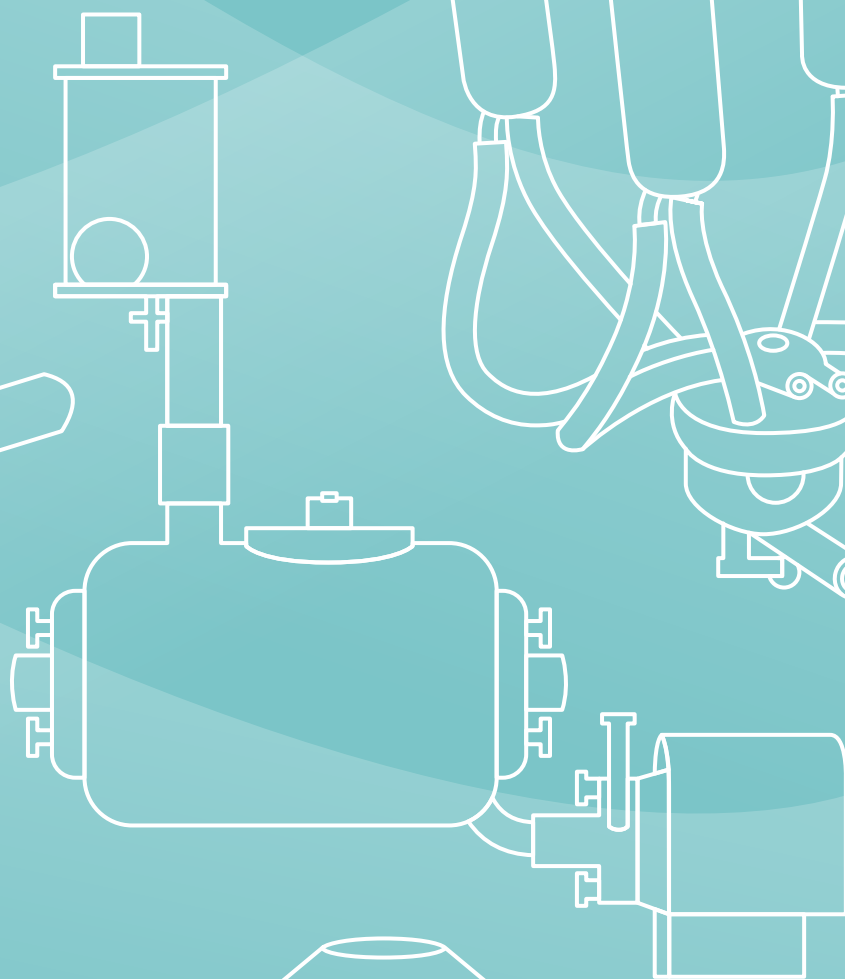
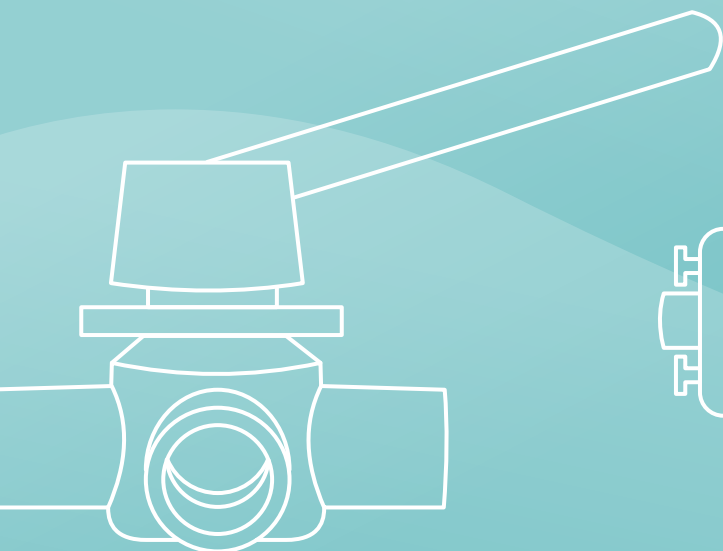
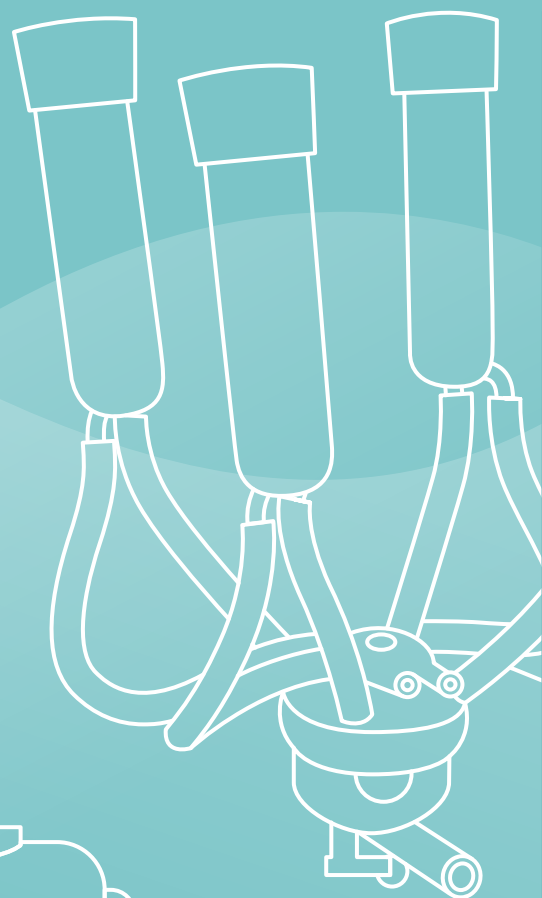
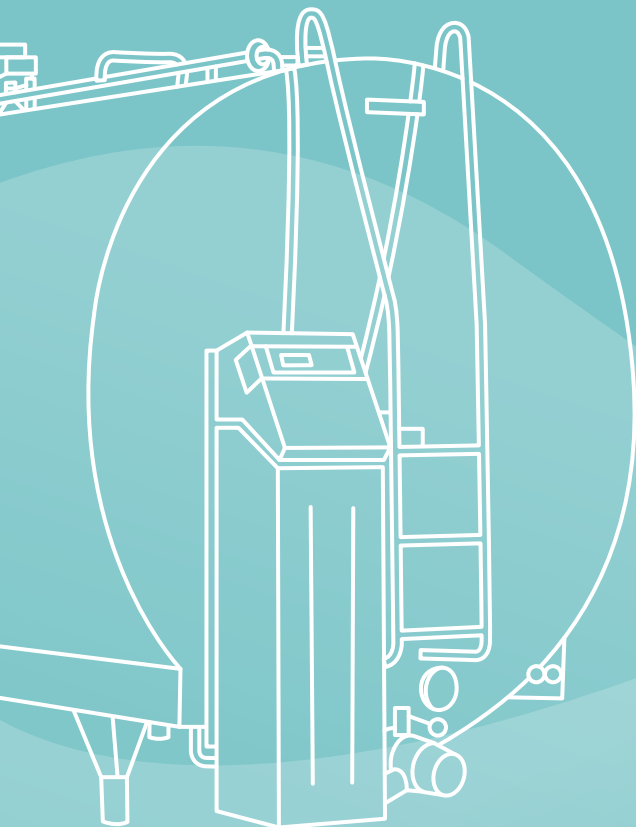

**RECI PROF**

**Reci Prof International b.v.**  
Nijverheidsweg 14  
5061 KL Oisterwijk  
The Netherlands